

ASH IMPORT & EXPORT LLC



Accessories  
And hardware

CODE	NAME	DIAMETER	LENGTH	FINISH	\$
ASH-0520	TAQUETE EXPANSOR "TX" C/TORNILLO 1/4" ANCHOR BOLT "TX" 1/4"	1/4"	2 1/2"	TROPICALIZADO TROPICALIZED	
ASH-0521	TAQUETE EXPANSOR "TX" C/TORNILLO 5/16« ANCHOR BOLT "TX" 5/16"	5/16"	2 1/2"	TROPICALIZADO TROPICALIZED	
ASH-0522	TAQUETE EXPANSOR "TX" C/TORNILLO 3/8" ANCHOR BOLT "TX" 3/8"	3/8"	3"	TROPICALIZADO TROPICALIZED	
ASH-0531	TAQUETE EXPANSOR "TX" C/TORNILLO 1/2" ANCHOR BOLT "TX" 1/2"	1/2"	3 1/4"	TROPICALIZADO TROPICALIZED	
ASH-0532	TAQUETE EXPANSOR "TX" C/TORNILLO 5/8« ANCHOR BOLT "TX" 5/8"	5/8"	4 "	TROPICALIZADO TROPICALIZED	
ASH-0533	TAQUETE EXPANSOR "TX" C/TORNILLO 3/4" ANCHOR BOLT "TX" 3/4"	3/4"	5 1/2"	TROPICALIZADO TROPICALIZED	



CODE	NAME	LENGTH	WIDTH	Ga	IN	FINISH	\$
ASH-0605	PLACA BASE SOLDABLE 4 Ø DE 3/16" 2X2 BASE PLATE 4 Ø OF 3/16" 2X2	2"	2"	0.187	3/16"	NEGRO BLACK	
ASH-0606	PLACA BASE SOLDABLE 4 Ø DE 3/16" 3X3 BASE PLATE 4 Ø OF 3/16" 3X3	3"	3"	0.187	3/16"	NEGRO BLACK	
ASH-0607	PLACA BASE SOLDABLE 4 Ø DE 3/16" 4X4 BASE PLATE 4 Ø OF 3/16 4X4	4"	4"	0.187	3/16"	NEGRO BLACK	
ASH-0608	PLACA BASE SOLDABLE 4 Ø DE 1/4" 6X6 BASE PLATE 4 Ø OF 1/4" 6X6	6"	6"	0.25	1/4"	NEGRO BLACK	
ASH-0609	PLACA BASE SOLDABLE 4 Ø DE 1/4" 8X8 BASE PLATE 4 Ø OF 1/4" 8X8	8"	8"	0.25	1/4"	NEGRO BLACK	
ASH-0701	PLACA BASE SOLDABLE 4 Ø DE 3/8" 10X10 BASE PLATE 4 Ø OF 3/8" 10X10	10"	10"	0.375	3/8"	NEGRO BLACK	
ASH-0702	PLACA BASE SOLDABLE 4 Ø DE 1/2" 12X12 BASE PLATE 4 Ø OF 1/2" 12X12	12"	12"	0.5	1/2"	NEGRO BLACK	

CODE	NAME	LENGTH	WIDTH	FINISH	\$
ASH-0154	JALADERA TROQUELADA 2 AGUJEROS DOOR HANDLE "2 HOLES"	4 3/4"	3/4"	GALVANIZADO GALVANIZED	
ASH-0155	JALADERA TROQUELADA 4 AGUJEROS DOOR HANDLE "4 HOLES"	6"	1 3/8"	GALVANIZADO GALVANIZED	



CODE	NAME	DIAMETER	LENGTH	WIDTH	SU	FINISH	\$
ASH-0601	BISAGRA BAT WING PARA PTR 3/4" HINGE BAT WING 3/4"	1/2"	1 1/2"	3/4"	SET	NEGRO BLACK	
ASH-0602	BISAGRA BAT WING PARA PTR 1" HINGE BAT WING 1"	1/2"	1 1/2"	1"	SET	NEGRO BLACK	

CODE	NAME	LENGTH	WIDTH	FINISH	\$
ASH-0661	MORDAZA PARA BARRA EN ACERO 3/8 X 3/8« FIXING CLAMP FOR STEEL GRINDER	3/8"	3/8"	GALVANIZADO GALVANIZED	
ASH-0660	MORDAZA PARA BARRA EN ACERO 3/8" X 1/4« FIXING CLAMP FOR STEEL GRINDER	3/8"	1/4"	GALVANIZADO GALVANIZED	



ABASTECEDORA DE SOLDADURA Y HERRAJES S.A. DE C.V.  
 MIY Y NORIEGA No. 304 NTE. C.P. 67100 CD. GUADALUPE, N.L. MEXICO  
 Conmutador: (81) 83-54-83-45 Fax: (81) 83-54-83-45  
 admonventas@ashmex.com www.ashmex.com

ASH IMPORT & EXPORT LLC  
 601-E CEDAR AVE, SUITE E MC ALLEN, TX 78501 USA  
 PHONE/FAX : (956) 8004448 CELL PHONE: (956) 3880948  
 ashiellc@hotmail.com ashimportexport@gmail.com www.ashmex.com



CODE	NAME	DIAMETER	LENGTH	WIDTH	FINISH	\$
ASH-0529	BISAGRA DE ACCION SENCILLA CON RESORTE 70MM.) 3" (2 PZAS.) HINGE "SINGLE ACTION WITH SPRING 3" (2 PIECES)	3"	2 3/4"	3"	NEGRO BLACK	

CODE	NAME	DIAMETER	LENGTH	WIDTH	Ga	FINISH	\$
ASH-0610	RODILLO DE HULE LATERAL PARA PORTON DESARMABLE 3" ROLLER "RUBBER" GUIDE 3 DEMOUNTABLE	2 1/2"	3 1/2"	3"	12	NATURAL	
ASH-0724	RODILLO DE HULE LATERAL PARA PORTON DESARMABLE 6" ROLLER "RUBBER" GUIDE 6" DEMOUNTABLE			6"	12	NATURAL	
ASH-0886	RODILLO DE HULE LATERAL ECONOMICO 3" CON SOLDADURA ROLLER "RUBBER" GUIDE 3" ECONOMIC W / WELDING			3"	12	NATURAL	
ASH-0887	RODILLO DE HULE LATERAL ECONOMICO 6" CON SOLDADURA ROLLER "RUBBER" GUIDE 6" ECONOMIC W / WELDING			6"	12	NATURAL	



CODE	NAME	DIAMETER	LENGTH	WIDTH	FINISH	\$
ASH-0523	PASADOR AMBIDIESTRO COLONIAL No.4 REF SLIDING BOLT AMBIDEXTROUS "COLONIAL" #4	5/8"	6"	5"	NEGRO BLACK	
ASH-0526	PASADOR AMBIDIESTRO COLONIA No.4 REF SLIDING BOLT AMBIDEXTROUS "COLONIAL" #4	5/8"	6"	5"	GALVANIZADO GALVANIZED	
ASH-0524	PASADOR AMBIDIESTRO COLONIAL No.6 REF SLIDING BOLT AMBIDEXTROUS "COLONIAL" #6	3/4"	8 1/2"	5"	NEGRO BLACK	
ASH-0527	PASADOR AMBIDIESTRO COLONIAL No.6 SLIDING BOLT AMBIDEXTROUS "COLONIAL" #6	3/4"	8 1/2"	5"	GALVANIZADO GALVANIZED	
ASH-0525	PASADOR AMBIDIESTRO COLONIAL No.7 SLIDING BOLT AMBIDEXTROUS "COLONIAL" #7	3/4"	10"	5 1/2"	NEGRO BLACK	
ASH-0528	PASADOR AMBIDIESTRO COLONIAL No.7 REF SLIDING BOLT AMBIDEXTROUS "COLONIAL" #7	3/4"	10"	5 1/2"	GALVANIZADO GALVANIZED	
ASH-0569	PASADOR AMBIDIESTRO COLONIAL No.9 EXTRA REF. SLIDING BOLT AMBIDEXTROUS "COLONIAL" #9	1"	13"	8"	NEGRO BLACK	
ASH-0621	PASADOR AMBIDIESTRO COLONIAL No.9 EXTRA REF. SLIDING BOLT AMBIDEXTROUS "COLONIAL" #9	1"	13"	8"	GALVANIZADO GALVANIZED	

CODE	NAME	DIAMETER	LENGTH	WIDTH	FINISH	\$
ASH-0257	PASADOR AMBIDIESTRO GALV. PESADO No.3 SLIDING BOLT AMBIDEXTROUS "CLASICO" #3	3/8"	3 1/2"	4 1/4"	GALVANIZADO GALVANIZED	
ASH-0258	PASADOR AMBIDIESTRO GALV. PESADO No.4 SLIDING BOLT AMBIDEXTROUS "CLASICO" #4	1/2"	4"	4 3/4"	GALVANIZADO GALVANIZED	
ASH-0259	PASADOR AMBIDIESTRO GALV. PESADO No.5 SLIDING BOLT AMBIDEXTROUS "CLASICO" #5	5/8"	5"	5 1/4"	GALVANIZADO GALVANIZED	
ASH-0260	PASADOR AMBIDIESTRO GALV. PESADO No.6 SLIDING BOLT AMBIDEXTROUS "CLASICO" #6	5/8"	6"	5 3/4"	GALVANIZADO GALVANIZED	
ASH-0651	PASADOR AMBIDIESTRO GALV. PESADO No.7 SLIDING BOLT AMBIDEXTROUS "CLASICO" #7	3/4"	11"	6"	GALVANIZADO GALVANIZED	



ABASTECEDORA DE SOLDADURA Y HERRAJES S.A. DE C.V.  
 MIER Y NORIEGA No. 304 NTE. C.P. 67100 CD. GUADALUPE, N.L. MEXICO  
 Conmutador: (81) 83-54-83-45 Fax: (81) 83-54-83-45  
 admonventas@ashmex.com www.ashmex.com

ASH IMPORT & EXPORT LLC  
 601-E CEDAR AVE, SUITE E MC ALLEN, TX 78501 USA  
 PHONE/FAX : (956) 8004448 CELL PHONE: (956) 3880948  
 ashllc@hotmail.com ashimportexport@gmail.com www.ashmex.com



CODE	NAME	DIAMETER	LENGTH	WIDTH	FINISH	\$
ASH-0478	PASADOR AMBIDIESTRO GIGANTE SOLIDO. No.15 SLIDING BOLT AMBIDEXTROUS "SOLID" #15	1 1/4"	15"	9"	GALVANIZADO GALVANIZED	



CODE	NAME	DIAMETER	FINISH	\$
ASH-0240	PASADOR AMBIDIESTRO RUSTICO No.4 REF. AMBIDEXTROUS SLIDING BOLT "RUSTIC" NO 4	5/8"	NEGRO BLACK	
ASH-0241	PASADOR AMBIDIESTRO RUSTICO No.5 REF. AMBIDEXTROUS SLIDING BOLT "RUSTIC" NO 5	5/8"	NEGRO BLACK	
ASH-0202	PASADOR AMBIDIESTRO RUSTICO No.5X EXTRA REF. AMBIDEXTROUS SLIDING BOLT "RUSTIC" NO 5XR	3/4"	NEGRO BLACK	
ASH-0242	PASADOR AMBIDIESTRO RUSTICO No.6 REF. AMBIDEXTROUS SLIDING BOLT "RUSTIC" NO 6	5/8"	NEGRO BLACK	
ASH-0203	PASADOR AMBIDIESTRO RUSTICO No.6X EXTRA REF. AMBIDEXTROUS SLIDING BOLT "RUSTIC" NO 6XR	3/4"	NEGRO BLACK	

CODE	NAME	DIAMETER	LENGTH	FINISH	\$
ASH-0166	PASADOR DE PISO DE BOLA DOBLE No. 9 CANE BOLT "BALL" NO.9	1/2"	9"	NEGRO BLACK	
ASH-0167	PASADOR DE PISO DE BOLA DOBLE No. 12 CANE BOLT "BALL" NO.12	1/2"	12"	NEGRO BLACK	
ASH-0168	PASADOR DE PISO DE BOLA DOBLE No. 16 CANE BOLT "BALL" NO.16	1/2"	16"	NEGRO BLACK	
ASH-0169	PASADOR DE PISO DE BOLA DOBLE No. 22. CANE BOLT "BALL" NO.22	1/2"	22"	NEGRO BLACK	



CODE	NAME	DIAMETER	LENGTH	WIDTH	Ga	FINISH	\$
ASH-0250	PASADOR DE PISO RUSTICO No.9 CANE BOLT "RUSTIC" NO. 9 Ø	5/8"	9"	1 1/4"	10	NEGRO BLACK	
ASH-0251	PASADOR DE PISO RUSTICO No.12 CANE BOLT "RUSTIC" NO.12 Ø	5/8"	12"	1 1/4"	10	NEGRO BLACK	
ASH-0252	PASADOR DE PISO RUSTICO No.16 CANE BOLT "RUSTIC" NO.16 Ø	5/8"	16"	1 1/4"	10	NEGRO BLACK	
ASH-0480	PASADOR DE PISO RUSTICO No. 18 CANE BOLT "RUSTIC" NO.18 Ø	5/8"	18"	1 1/4"	10	NEGRO BLACK	
ASH-0253	PASADOR DE PISO RUSTICO No. 22 CANE BOLT "RUSTIC" NO.22 Ø	5/8"	22"	1 1/4"	10	NEGRO BLACK	

**ABASTECEDORA DE SOLDADURA Y HERRAJES S.A. DE C.V.**  
 MIYER Y NORIEGA No. 304 NTE. C.P. 67100 CD. GUADALUPE, N.L. MEXICO  
 Conmutador: (81) 83-54-83-45 Fax: (81) 83-54-83-45  
 admonventas@ashmex.com www.ashmex.com

**ASH IMPORT & EXPORT LLC**  
 601-E CEDAR AVE, SUITE E MC ALLEN, TX 78501 USA  
 PHONE/FAX : (956) 8004448 CELL PHONE: (956) 3880948  
 ashie LLC@hotmail.com ashimportexport@gmail.com www.ashmex.com

CODE	NAME	FINISH	Ga	\$
ASH-0708	PASADOR DEL No. 3 REF. Ø 1/2 SLIDING BOLT NO. 3 REF. Ø 1/2	NATURAL	12	



CODE	NAME	LENGTH	WIDTH	FINISH	\$
ASH-0254	PASADOR PORTACANDADO No. 2 SLIDING BOLT "LOCK HOLDER" NO. 2	2 3/4"	1 1/2"	GALVANIZADO GALVANIZED	
ASH-0255	PASADOR PORTACANDADO No. 4 SLIDING BOLT "LOCK HOLDER" NO. 4	4 1/2"	2"	GALVANIZADO GALVANIZED	
ASH-0256	PASADOR PORTACANDADO No. 6 SLIDING BOLT "LOCK HOLDER" NO. 6			GALVANIZADO GALVANIZED	



CODE	NAME	LENGTH	WIDTH	FINISH	\$
ASH-0244	CERROJO REF. No. (80-30) 1 1/4" REINFORCED BARREL BOLT NO. (80-30) 1 1/4 "	1 1/4 "	1 1/4 "	GALVANIZADO GALVANIZED	0.5
ASH-0243	CERROJO REF. No. (80-40) 1 1/2« REINFORCED BARREL BOLT NO. (80-40) 1 1/2 "	1 1/2 "	1 1/2 "	GALVANIZADO GALVANIZED	0.55
ASH-0245	CERROJO REF. No. (80-50) 2 " REINFORCED BARREL BOLT NO. (80-50) 2 "	2"	2 "	GALVANIZADO GALVANIZED	0.62
ASH-0246	CERROJO REF. No. (80-60) 2 1/2" REINFORCED BARREL BOLT NO. (80-60) 2 1/2"	2 1/2 "	2 1/2 "	GALVANIZADO GALVANIZED	0.67
ASH-0247	CERROJO REF. No. (80-75) 3" REINFORCED BARREL BOLT NO. (80-75) 3"	3"	3 "	GALVANIZADO GALVANIZED	0.75



CODE	NAME	LENGTH	WIDTH	Ga	FINISH	\$
ASH-0173	PASADOR MULTIUSOS No. 4 CUAD.1/2 SLIDING BOLT MULTIPLE PORPOUSE NO. 4	6"	2"	14	TROPICALIZADO TROPICALIZED	
ASH-0187	PASADOR MULTIUSOS No. 5 CUAD.5/8 SLIDING BOLT MULTIPLE PORPOUSE NO. 5	8"	2"	14	TROPICALIZADO TROPICALIZED	

CODE	NAME	LENGTH	WIDTH	FINISH	\$
ASH-0078	BROCHE OREJA DE RATON RADIAL SIN CONTRA RADIAL WINDOW SLASH LOCK	2 7/8"	1 1/2"	GALVANIZADO GALVANIZED	



CODE	NAME	LENGTH	FINISH	\$
ASHD-0277	RESORTE PARA PUERTA MOSQUITERA DOOR SPRING	16 1/4"	GALVANIZADO GALVANIZED	

CODE	NAME	LENGTH	WIDTH	FINISH	\$
ASH-0286	SUJETA RIEL PARA RIEL PESADO ( 1500 - 9000 ) SQUARE BRACKET FOR HEAVY TRACK (1500-9000)	5"	2 1/4"	GALVANIZADO GALVANIZED	

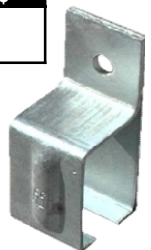

ABASTECEDORA DE SOLDADURA Y HERRAJES S.A. DE C.V.  
 MIYER Y NORIEGA No. 304 NTE. C.P. 67100 CD. GUADALUPE, N.L. MEXICO  
 Conmutador: (81) 83-54-83-45 Fax: (81) 83-54-83-45  
 admonventas@ashmex.com www.ashmex.com

ASH IMPORT & EXPORT LLC  
 601-E CEDAR AVE, SUITE E MC ALLEN, TX 78501 USA  
 PHONE/FAX : (956) 8004448 CELL PHONE: (956) 3880948  
 ashiellc@hotmail.com ashimportexport@gmail.com www.ashmex.com

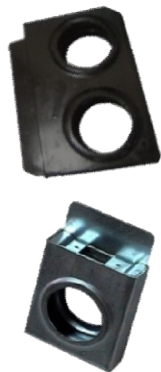

CODE	NAME	FINISH	DIAMETER	LENGTH	WIDTH	THICKNESS	Ga	\$
ASH-0509	PORTA CHAPA EMBUTIDO DOBLE 1" LOCK BOX "STAMPED" "DOUBLE" NEW 1"	NATURAL	2 1/8"	7"	5 1/2"	1"	14	
ASH-0271	PORTA CHAPA EMBUTIDO DOBLE 1" LOCK BOX "STAMPED" "DOUBLE" NEW 1"	GALV	2 1/8"	7"	5 1/2"	1"	14	
ASH-0510	PORTA CHAPA EMBUTIDO SENCILLO 1" LOCK BOX "STAMPED" "SINGLE" NEW 1"	NATURAL	2 1/8"	4 1/4"	3 1/2"	1"	14	
ASH-0272	PORTA CHAPA EMBUTIDO SENCILLO 1" LOCK BOX "STAMPED" "SINGLE" NEW 1"	GALV	2 1/8"	4 1/4"	3 1/2"	1"	14	

CODE	NAME	DIAMETER	LENGTH	WIDTH	Ga	FINISH	\$
ASH-0611	PORTA CHAPA LISO DOBLE 1 1/4" LOCK BOX "PLAIN" "DOUBLE" 1 1/4"	2 1/8"	6 3/4"	5 1/2"	14	NATURAL	
ASH-0614	PORTA CHAPA LISO DOBLE 1 1/4" LOCK BOX "PLAIN" "DOUBLE" 1 1/4"	2 1/8"	6 3/4"	5 1/2"	14	GALV	
ASH-0612	PORTA CHAPA LISO SENCILLO 1 1/4" LOCK BOX "PLAIN" "SINGLE" 1 1/4"	2 1/8"	5 1/2"	3 1/2"	14	NATURAL	
ASH-0615	PORTA CHAPA LISO SENCILLO 1 1/4" LOCK BOX "PLAIN" "SINGLE" 1 1/4"	2 1/8"	5 1/2"	3 1/2"	14	GALV	

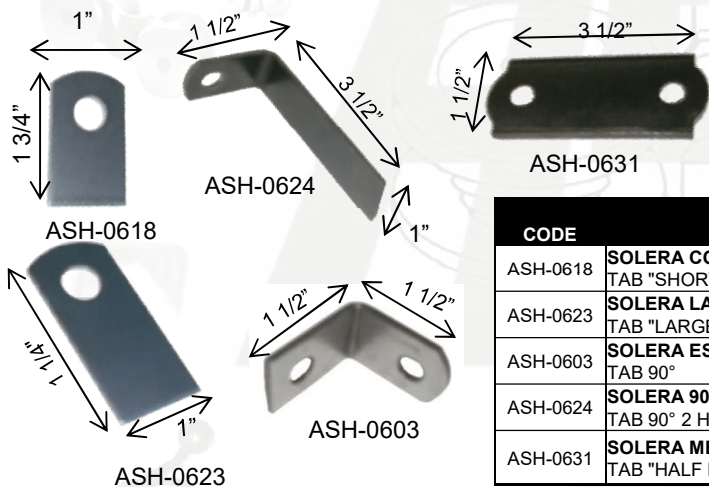

## STEEL WELD

CODE	NAME	DIAMETER	LENGTH	WIDTH	Ga	FINISH	\$
ASH-0618	SOLERA CORTA TAB "SHORT"	3/8"	1 3/4"	1"	3/16	NATURAL	
ASH-0623	SOLERA LARGA TAB "LARGE"	3/8"	2 1/4"	1"	3/16	NATURAL	
ASH-0603	SOLERA ESCUADRA 90° TAB 90°	3/8"	3 1/2" X 1 1/2"	1"	3/16	NATURAL	
ASH-0624	SOLERA 90° 2 AGUEJEROS TAB 90° 2 HOLES	3/8"	1 1/2" X 1 1/2"	1"	3/16	NATURAL	
ASH-0631	SOLERA MEDIA LUNA TAB "HALF MOON" "2 HOLES"	3/8"	3 1/2"	1 1/2"	3/16	NATURAL	

CODE	NAME	DIAMETER	LENGTH	WIDTH	THICKNESS	BASE	FINISH	\$
ASH-0727	PUNTA DE SOLERA "FLOR" TABS ARROW "FLOWER"	3/8"	2 7/8"	2 5/8"	1/8"		NATURAL	
ASH-0729	PUNTA DE SOLERA "FLOR DE LIZ" TABS ARROW "LIZ FLOWER"	3/8"	2 5/8"	2"	1/8"		NATURAL	
ASH-0730	PUNTA ANGULO "FLOR" TABS ANGLE ARROW "FLOWER"	3/8"	2 7/8"	2 5/8"	1/8"	1"	NATURAL	
ASH-0732	PUNTA ANGULO "FLOR DE LIZ" TABS ANGLE ARROW "LIZ FLOWER"	3/8"	2 5/8"	2"	1/8"	1"	NATURAL	

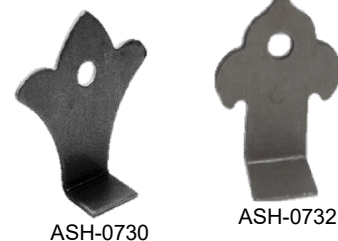
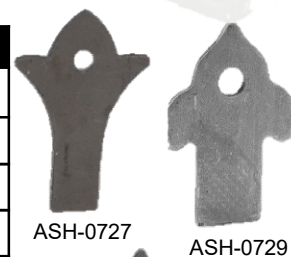

ABASTECEDORA DE SOLDADURA Y HERRAJES S.A. DE C.V.  
 MIER Y NORIEGA No. 304 NTE. C.P. 67100 CD. GUADALUPE, N.L. MEXICO  
 Conmutador: (81) 83-54-83-45 Fax: (81) 83-54-83-45  
 admonventas@ashmex.com www.ashmex.com

ASH IMPORT & EXPORT LLC  
 601-E CEDAR AVE, SUITE E MC ALLEN, TX 78501 USA  
 PHONE/FAX : (956) 8004448 CELL PHONE: (956) 3880948  
 ashiellc@hotmail.com ashimportexport@gmail.com www.ashmex.com

CODE	NAME	LENGTH	WIDTH	Ga	FINISH	\$
ASHT-0125	ALA DE ANGEL DERECHA AL-100 ANGEL WING "RIGHT"	4 3/8"	1 5/8"	14	NATURAL	\$ 0.43
ASHT-0126	ALA DE ANGEL IZQUIERDA AL-100 ANGEL WING "LEFT"	4 3/8"	1 5/8"	14	NATURAL	\$ 0.43



CODE	NAME	LENGTH	THICKNESS	FINISH	\$
ASHT-0014	CANASTA B-521 BASKET B-521 (2 1/4" D 5 1/4" H) [ ] 1/2"	5 1/4"	2 1/4"	NATURAL	
ASHT-0039	CANASTA B-520 BASKET B-520 (1 3/4" D 5" H) [ ] 1/2"	5"	1 3/4"	NATURAL	
ASHT-0051	CANASTA B-522 BASKET B-522 (2 1/4" D 5 1/2" H) [ ] 1/2"	5 1/2"	2 1/4"	NATURAL	

CODE	NAME	LENGTH	WIDTH	FINISH	\$
ASH-0921	CLIP PARA POLIN 3" STEEL BRACKER 3" "PLAIN"	3"	2 1/4"	NATURAL	
ASH-0626	CLIP PARA POLIN 4" STEEL BRACKER 4" "PLAIN"	4"	2 1/4"	NATURAL	
ASH-0627	CLIP PARA POLIN 5" STEEL BRACKER 5" "PLAIN"	5"	2 1/4"	NATURAL	
ASH-0628	CLIP PARA POLIN 6" STEEL BRACKER 6" "PLAIN"	6"	2 1/4"	NATURAL	
ASH-0629	CLIP PARA POLIN 8" STEEL BRACKER 8" "PLAIN"	8"	2 1/4"	NATURAL	
ASH-0630	CLIP PARA POLIN 10" STEEL BRACKER 10" "PLAIN"	10"	2 1/4"	NATURAL	

CODE	NAME	DIAMETER	Ga	FINISH	\$
ASH-0450	ESFERA TROQUELADA 1" ENTRADA SENCILLA SPHERE "STAMPED" 1" "SINGLE ENTRY"	1"	20	NATURAL	
ASH-0451	ESFERA TROQUELADA 1 1/2" ENTRADA DOBLE SPHERE "STAMPED" 1 1/2" "DOUBLE ENTRY"	1 1/2"	20	NATURAL	
ASH-0452	ESFERA TROQUELADA 1 1/2" ENTRADA SENCILLA SPHERE "STAMPED" 1 1/2" "SINGLE ENTRY"	1 1/2"	20	NATURAL	
ASH-0453	ESFERA TROQUELADA 2" ENTRADA DOBLE SPHERE "STAMPED" 2" "DOUBLE ENTRY"	2"	20	NATURAL	
ASH-0454	ESFERA TROQUELADA 2" ENTRADA SENCILLA SPHERE "STAMPED" 2" "SINGLE ENTRY"	2"	20	NATURAL	



CODE	NAME	LENGTH	FINISH	\$
ASH-0704	RIEL GUIA EN ANGULO P/ RUEDAS MAQUINADAS Y FO VO GUIDE RAIL ANGLED FOR STEEL AND CAST IRON WHEEL	10 ft	GALVANIZADO GALVANIZED	

CODE	NAME	LENGTH	WIDTH	HIGHT	\$
ASH-0499	ASADOR PORTATIL DE FIERRO VACIADO A.S.H. CAST IRON PORTABLE GRILL/STAINLESS STEEL MESH	22.5"	18"	18"	



CODIGO	NAME	MODELO	PESO	WEIGHT LB	\$
ESSO-0010	SOLDADURA 6011 1/8" ESAB SUPER 11 "CON GRAFITO" WELDING ELECTRODE 6011 1/8" ASH	S6111432C	10 KG	22	
ESSO-0030	SOLDADURA 6013 1/8" A.S.H. ESAB "PUNTA VERDE" WELDING ELECTRODE 6013 1/8" ASH		10 KG	22	

**ABASTECEDORA DE SOLDADURA Y HERRAJES S.A. DE C.V.**  
 MIER Y NORIEGA No. 304 NTE. C.P. 67100 CD. GUADALUPE, N.L. MEXICO  
 Conmutador: (81) 83-54-83-45 Fax: (81) 83-54-83-45  
 admonventas@ashmex.com www.ashmex.com

**ASH IMPORT & EXPORT LLC**  
 601-E CEDAR AVE, SUITE E MC ALLEN, TX 78501 USA  
 PHONE/FAX : (956) 8004448 CELL PHONE: (956) 3880948  
 ashiellc@hotmail.com ashimportexport@gmail.com www.ashmex.com

CODE	NAME	\$
MKH-1001	DISCO DE CORTE METAL 14" X 1/8" X 1" MAKITA 14" CUTTING DISC MAKITA	\$3.21



## HEAVY DUTY GATE SPRING ROLLER

CODE	NAME	LENGTH	WIDTH	FINISH	\$
ASH-0667	MECANISMO CON RESORTE PARA PUERTA CORREDIZA SIN RUEDA SPRING MECHANISM FOR SLIDING DOOR WITHOUT WHEEL	12 1/2"	3" 3/4"	NATURAL	
ASH-0707	MECANISMO CON RESORTE PARA PUERTA CORREDIZA CON RUEDA SPRING MECHANISM FOR SLIDING DOOR WITH WHEEL	17"	4 1/2"	NATURAL	

CODE	NAME	DIAMETER	LENGTH	WIDTH	THICKNESS	FINISH	\$
ASH-0507	BISAGRA BIBEL 1/4 X 2-1/2" GIGANTE HINGE MALE PIN "BIG" "BIBEL" 1/4 X 2 1/2"	5/8"	6 3/4"	2 1/2"	1/4"	NATURAL	
ASH-0506	BISAGRA BIBEL 1/4 X 2" GRANDE HINGE MALE PIN "LARGE" "BIBEL" 1/4 X 2"	5/8"	8"	2"	1/4"	NATURAL	



CODE	NAME	DIAMETER	LENGTH	FINISH	\$
ASH-0426	BISAGRA TUBULAR CON GRASERA MAQUINADA 5/8" HINGE MACHINED BARREL 5/8" G.F.	5/8"	3 3/8"	NATURAL	
ASH-0427	BISAGRA TUBULAR CON GRASERA MAQUINADA 3/4" HINGE MACHINED BARREL 3/4" G.F.	3/4"	3 3/4"	NATURAL	
ASH-0060	BISAGRA TUBULAR CON GRASERA MAQUINADA 1" HINGE MACHINED BARREL 1" G.F.	1"	4"	NATURAL	
ASH-0061	BISAGRA TUBULAR CON GRASERA MAQUINADA 1 1/4" HINGE MACHINED BARREL 1 1/4" G.F.	1 1/4"	4 1/2"	NATURAL	
ASH-0062	BISAGRA TUBULAR CON GRASERA MAQUINADA 1 1/2" HINGE MACHINED BARREL 1 1/2" G.F.	1 1/2"	4 3/4"	NATURAL	
ASH-0063	BISAGRA TUBULAR CON GRASERA MAQUINADA 2" HINGE MACHINED BARREL 2" G.F.	2"	6"	NATURAL	



CODE	NAME	DIAMETER	LENGTH	FINISH	\$
ASH-0047	BISAGRA TEJUELO 1" HINGE "TEJUELO BARREL" 1"	1"	1 1/4"	NATURAL	
ASH-0049	BISAGRA TEJUELO 1 1/4" HINGE "TEJUELO BARREL" 1 1/4"	1 1/4"	1 1/2"	NATURAL	
ASH-0051	BISAGRA TEJUELO 1 1/2" HINGE "TEJUELO BARREL" 1 1/2"	1 1/2"	1 1/2"	NATURAL	
ASH-0053	BISAGRA TEJUELO 2" HINGE "TEJUELO BARREL" 2"	2"	1 1/2"	NATURAL	
ASH-0432	BISAGRA TEJUELO 2 1/2" HINGE "TEJUELO BARREL" 2 1/2"	2 1/2"	1 3/4"	NATURAL	
ASH-0433	BISAGRA TEJUELO 3" HINGE "TEJUELO BARREL" 3"	3"	2 1/2"	NATURAL	



ABASTECEDORA DE SOLDADURA Y HERRAJES S.A. DE C.V.  
MIER Y NORIEGA No. 304 NTE. C.P. 67100 CD. GUADALUPE, N.L. MEXICO  
Conmutador: (81) 83-54-83-45 Fax: (81) 83-54-83-45  
admonventas@ashmex.com www.ashmex.com

ASH IMPORT & EXPORT LLC  
601-E CEDAR AVE, SUITE E MC ALLEN, TX 78501 USA  
PHONE/FAX : (956) 8004448 CELL PHONE: (956) 3880948  
ashiellc@hotmail.com ashimportexport@gmail.com www.ashmex.com







CODE	NAME	DIAMETER	LENGTH	WIDTH	FINISH	\$
ASH-0035	BISAGRA DE ANCLA 3/4" HINGE ANCHOR 3/4"	3/4"	4"	4"	NATURAL	
ASH-0036	BISAGRA DE ANCLA 1" HINGE ANCHOR 1"	1"	4"	4"	NATURAL	
ASH-0038	BISAGRA DE ANCLA 1 1/4" HINGE ANCHOR 1 1/4"	1 1/4"	4"	4"	NATURAL	
ASH-0037	BISAGRA DE ANCLA 1 1/2" HINGE ANCHOR 1 1/2"	1 1/2"	5 1/4"	4 1/2"	NATURAL	
ASH-0039	BISAGRA DE ANCLA 2" HINGE ANCHOR 2"	2"	6"	5 1/4"	NATURAL	

CODE	NAME	DIAMETER	LENGTH	FINISH	\$
ASH-0067	BISAGRA TUBULAR PULIDA FORJADA 3/8" HINGE FORGED BARREL 3/8"	3/8"	2 3/8"	NATURAL	
ASH-0068	BISAGRA TUBULAR PULIDA FORJADA 1/2" HINGE FORGED BARREL 1/2"	1/2"	2 3/8"	NATURAL	
ASH-0069	BISAGRA TUBULAR PULIDA FORJADA 5/8" HINGE FORGED BARREL 5/8"	5/8"	2 3/8"	NATURAL	



CODE	NAME	DIAMETER	LENGTH	FINISH	\$
ASH-0146	BISAGRA TUBULAR MAQUINADA 1/2" HINGE MACHINED BARREL 1/2"	1/2"	2 1/4"	NATURAL	
ASH-0147	BISAGRA TUBULAR MAQUINADA 5/8" HINGE MACHINED BARREL 5/8"	5/8"	2 3/8"	NATURAL	
ASH-0058	BISAGRA TUBULAR MAQUINADA 3/4" HINGE MACHINED BARREL 3/4"	3/4"	2 3/4"	NATURAL	
ASH-0059	BISAGRA TUBULAR MAQUINADA 1" HINGE MACHINED BARREL 1"	1"	3 1/2"	NATURAL	



CODIGO	DESCRIPCION	DIAMETER	FINISH	\$
ASH-0574	BISAGRA TUBULAR PULIDA DOBLE DE 3/4" CON 2 GRAS 2 HEM DOUBLE HINGE POLISHED BARREL 3/4" W/ 2 FITTINGS	3/4"	NATURAL	
ASH-0573	BISAGRA TUBULAR PULIDA DOBLE DE 1" CON 2 GRAS 2 HEM DOUBLE HINGE POLISHED BARREL 1" W/ 2 FITTINGS	1"	NATURAL	
ASH-0575	BISAGRA TUBULAR PULIDA DOBLE DE 1 1/4" CON 2 GRAS 2 HEM DOUBLE HINGE POLISHED BARREL 1 1/4" W/ 2 FITTINGS	1 1/4"	NATURAL	
ASH-0576	BISAGRA TUBULAR PULIDA DOBLE DE 1 1/2" CON 2 GRAS 2 HEM DOUBLE HINGE POLISHED BARREL 1 1/2" W/ 2 FITTINGS.	1 1/2"	NATURAL	



CODE	NAME	DIAMETER	LENGTH	WIDTH	FINISH	\$
ASH-0546	BISAGRA TUBULAR CON PLACA 1" HINGE BARREL "PLATE" 1" W/ GREASE FITTING	1"	5"	1"	NATURAL	
ASH-0671	BISAGRA TUBULAR CON PLACA 1 1/4" HINGE BARREL "PLATE" 1 1/4" W/ GREASE FITTING	1 1/4"	6"	3/8"	NATURAL	
ASH-0547	BISAGRA TUBULAR CON PLACA 1 1/2" HINGE BARREL "PLATE" 1 1/2" W/ GREASE FITTING	1 1/2"	7"	3/8"	NATURAL	
ASH-0672	BISAGRA TUBULAR CON PLACA 2" HINGE BARREL "PLATE" 2" W/ GREASE FITTING	2"	8"	3/8"	NATURAL	

ABASTECEDORA DE SOLDADURA Y HERRAJES S.A. DE C.V.  
 MIYER Y NORIEGA No. 304 NTE. C.P. 67100 CD. GUADALUPE, N.L. MEXICO  
 Conmutador: (81) 83-54-83-45 Fax: (81) 83-54-83-45  
 admonventas@ashmex.com www.ashmex.com

ASH IMPORT & EXPORT LLC  
 601-E CEDAR AVE, SUITE E MC ALLEN, TX 78501 USA  
 PHONE/FAX : (956) 8004448 CELL PHONE: (956) 3880948  
 ashie LLC@hotmail.com ashimportexport@gmail.com www.ashmex.com

CODE	NAME	FINISH	\$
ASH-0178	BISAGRA BALERO MULTIUSOS SELLADA PULIDA 1 1/4" 1 1/4" MULTIPLE USES BEARING HINGE	NATURAL	
ASH-0179	BISAGRA BALERO MULTIUSOS SELLADA PULIDA 1 1/2" 1 1/2" MULTIPLE USES BEARING HINGE	NATURAL	
ASH-0180	BISAGRA BALERO MULTIUSOS SELLADA PULIDA 2" 2" MULTIPLE USES BEARING HINGE	NATURAL	



CODE	NAME	FINISH	\$
ASH-0888	BISAGRA RECTANGULAR CON GRASERA 4" X 1" X 1/2" RECTANGULAR BOX HINGES WITH PIN 4" X 1" X 1/2"	NATURAL	
ASH-0889	BISAGRA RECTANGULAR CON GRASERA 5" X 1 1/2" X 3/4" RECTANGULAR BOX HINGES WITH PIN 5" X 1 1/2" X 3/4"	NATURAL	
ASH-0890	BISAGRA RECTANGULAR CON GRASERA 6" X 2" X 1" RECTANGULAR BOX HINGES WITH PIN 6" X 2" X 1"	NATURAL	

CODE	NAME	FINISH	\$
ASH-0763	BIS. TUBULAR SOLIDA PERNO SUELTO 1" X 3 1/2" HINGE MACHINED BARREL W/ REMOVABLE PIN 1" X 3 1/2" PIN : 5/8" X 2 3/4"	NATURAL	
ASH-0764	BIS. TUBULAR SOLIDA PERNO SUELTO 3/4" X 2 3/4" HINGE MACHINED BARREL W/ REMOVABLE PIN 3/4" X 2 3/4" PIN: 7/16" X 2"	NATURAL	
ASH-0765	BIS. TUBULAR SOLIDA PERNO SUELTO 5/8" X 2 5/16" HINGE MACHINED BARREL W/ REMOVABLE PIN 5/8" X 2 5/16" PIN: 5/16" X 1.62"	NATURAL	

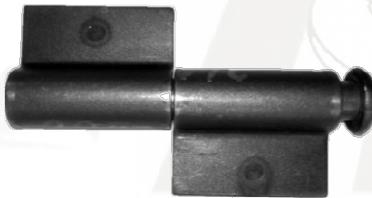

CODE	NAME	LENGTH	P.L.
ASH-1000	BISAGRA TIPO BANDERA CAL 11 PERNO SUELTO DE 1/2" CON CABEZA PLUG HINGE WITH RIGHT AND LEFT WINGS 4"	4"	
ASH-1006	BISAGRA TIPO BANDERA CAL 11 PERNO SUELTO DE 3/8" CON CABEZA PLUG HINGE WITH RIGHT AND LEFT WINGS 3"	3"	

CODE	NAME	LENGTH	P.L.
ASH-1001	BISAGRA DOBLE TUBO CED. 40 1" X 6 1/4" CON PERNO SUELTO 3/4" PIPE DOUBLE HINGE SCHEDULE 40 WITH REMOVABLE PIN 3/4"	6 1/4"	



CODE	NAME	LENGTH	P.L.
ASH-1003	ANCLA ROSCADA PARA BASE DE 5/8" X 10" ADJUSTABLE GATE HANGER BOLT 5/8"	10"	

CODE	NAME	LENGTH	WIDTH	FINISH	\$
ASH-0673	BISAGRA CIEGA CUAD. 2X2 GRUESA HEAVY DUTY STEEL HINGE 14 Ga. 2" X 2"	2"	2"	NATURAL	
ASH-0674	BISAGRA CIEGA CUAD. 3X3 GRUESA HEAVY DUTY STEEL HINGE 13 Ga 3" X 3"	3"	3"	NATURAL	
ASH-0690	BISAGRA CIEGA CUAD. 3.5" X 2 1/4" GRUESA HEAVY DUTY STEEL HINGE 14 Ga. 3.5" X 2 1/4"	3.5"	2 1/4"	NATURAL	
ASH-0675	BISAGRA CIEGA CUAD. 3.5X3.5 GRUESA HEAVY DUTY STEEL HINGE 13 Ga 3.5" X 3.5"	3.5"	3.5"	NATURAL	
ASH-0676	BISAGRA CIEGA CUAD. 4X4 GRUESA HEAVY DUTY STEEL HINGE 12 Ga 4" X 4"	4"	4"	NATURAL	



ABASTECEDORA DE SOLDADURA Y HERRAJES S.A. DE C.V.  
 MIY Y NORIEGA No. 304 NTE. C.P. 67100 CD. GUADALUPE, N.L. MEXICO  
 Conmutador: (81) 83-54-83-45 Fax: (81) 83-54-83-45  
 admonventas@ashmex.com www.ashmex.com

ASH IMPORT & EXPORT LLC  
 601-E CEDAR AVE, SUITE E MC ALLEN, TX 78501 USA  
 PHONE/FAX : (956) 8004448 CELL PHONE: (956) 3880948  
 ashiellc@hotmail.com ashimportexport@gmail.com www.ashmex.com

CODE	NAME	DIAMETER	FINISH
ASH-0633	PLATO PORTA VELA "PIEZA" CURVO 1 1/2" CANDLE DRIP PAN "CURVE" 1 1/2"	1 1/2"	NATURAL
ASH-0634	PLATO PORTA VELA "PIEZA" CURVO 2" CANDLE DRIP PAN "CURVE" 2"	2"	NATURAL
ASH-0635	PLATO PORTA VELA "PIEZA" CURVO 2 1/2" CANDLE DRIP PAN "CURVE" 2 1/2"	2 1/2"	NATURAL
ASH-0636	PLATO PORTA VELA "PIEZA" CURVO 3" CANDLE DRIP PAN "CURVE" 3"	3"	NATURAL
ASH-0637	PLATO PORTA VELA "PIEZA" CURVO 4" CANDLE DRIP PAN "CURVE" 4"	4"	NATURAL
ASH-0638	PLATO PORTA VELA "PIEZA" CURVO 6" CANDLE DRIP PAN "CURVE" 6"	6"	NATURAL
ASH-0639	PLATO PORTA VELA "PIEZA" CURVO 8" CANDLE DRIP PAN "CURVE" 8"	8"	NATURAL

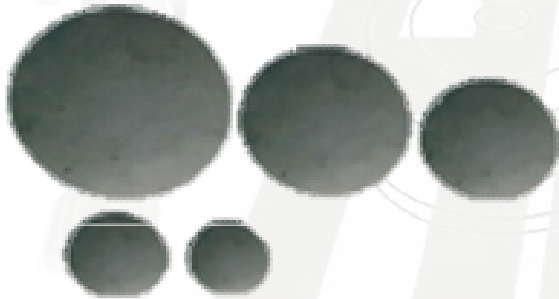

CODE	NAME	DIAMETER	FINISH
ASH-0640	PLATO PORTA VELA "PIEZA" LISO 1 1/2" CANDLE DRIP PAN "PLAIN" 1 1/2"	1 1/2"	NATURAL
ASH-0641	PLATO PORTA VELA "PIEZA" LISO 2" CANDLE DRIP PAN "PLAIN" 2"	2"	NATURAL
ASH-0642	PLATO PORTA VELA "PIEZA" LISO 3" CANDLE DRIP PAN "PLAIN" 3"	3"	NATURAL
ASH-0643	PLATO PORTA VELA "PIEZA" LISO 4" CANDLE DRIP PAN "PLAIN" 4"	4"	NATURAL
ASH-0644	PLATO PORTA VELA "PIEZA" LISO 6" CANDLE DRIP PAN "PLAIN" 6"	6"	NATURAL
ASH-0645	PLATO PORTA VELA "PIEZA" LISO 8" CANDLE DRIP PAN "PLAIN" 8"	8"	NATURAL

CODE	NAME	Ga	FINISH
ASH-0734	TAPA PARA TUBO 3/4" (1/2 ESFERA-BOTON) HALF BALL END CAP 3/4"	14	NATURAL
ASH-0736	TAPA PARA TUBO 1" (1/2 ESFERA-BOTON) HALF BALL END CAP 1"	14	NATURAL
ASH-0737	TAPA PARA TUBO 1 1/4" (1/2 ESFERA-BOTON) HALF BALL END CAP 1 1/4"	14	NATURAL
ASH-0738	TAPA PARA TUBO 1 1/2" (1/2 ESFERA-BOTON) HALF BALL END CAP 1-1/2"	14	NATURAL
ASH-0739	TAPA PARA TUBO 2" (1/2 ESFERA-BOTON) HALF BALL END CAP 2"	14	NATURAL
ASH-0740	TAPA PARA TUBO 2 1/2" (1/2 ESFERA-BOTON) HALF BALL END CAP 2 1/2"	14	NATURAL
ASH-0741	TAPA PARA TUBO 3" (1/2 ESFERA-BOTON) HALF BALL END CAP 3"	12	NATURAL
ASH-0743	TAPA PARA TUBO 4" (1/2 ESFERA-BOTON) HALF BALL END CAP 4"	12	NATURAL

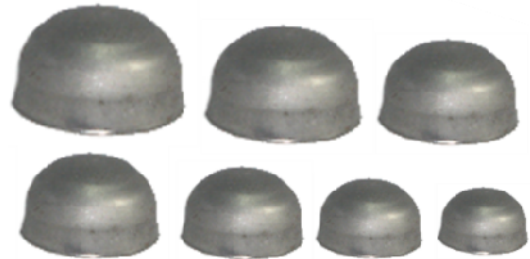

ABASTECEDORA DE SOLDADURA Y HERRAJES S.A. DE C.V.  
 MIER Y NORIEGA No. 304 NTE. C.P. 67100 CD. GUADALUPE, N.L. MEXICO  
 Conmutador: (81) 83-54-83-45 Fax: (81) 83-54-83-45  
 admonventas@ashmex.com www.ashmex.com

ASH IMPORT & EXPORT LLC  
 601-E CEDAR AVE, SUITE E MC ALLEN, TX 78501 USA  
 PHONE/FAX : (956) 8004448 CELL PHONE: (956) 3880948  
 ashiellc@hotmail.com ashimportexport@gmail.com www.ashmex.com

CODE	NAME	Ga
ASH-0657	TAPA PARA PTR 1/2" DECORATIVA PRESSED POST CAPS 1/2"	18
ASH-0655	TAPA PARA PTR 3/4" DECORATIVA PRESSED POST CAPS 3/4"	18
ASH-0653	TAPA PARA PTR 1" DECORATIVA PRESSED POST CAPS 1"	18
ASH-0656	TAPA PARA PTR 1 1/4" DECORATIVA PRESSED POST CAPS 1 1/4"	16
ASH-0654	TAPA PARA PTR 1 1/2" DECORATIVA PRESSED POST CAPS 1-1/2"	16
ASH-0646	TAPA PARA PTR 2" DECORATIVA PRESSED POST CAPS 2"	14
ASH-0647	TAPA PARA PTR 2 1/2" DECORATIVA PRESSED POST CAPS 2 1/2"	14
ASH-0648	TAPA PARA PTR 3" DECORATIVA PRESSED POST CAPS 3"	14
ASH-0650	TAPA PARA PTR 4" DECORATIVA PRESSED POST CAPS 4"	12



CODE	NAME	Ga	FINISH
ASH-0772	TAPA PARA TUBO MECANICO 3/4" HALF BALL END CAP MECHANICAL TUBE 3/4" Ga. 12	12	NATURAL
ASH-0773	TAPA PARA TUBO MECANICO 1" HALF BALL END CAP MECHANICAL TUBE 1" Ga. 12	12	NATURAL
ASH-0774	TAPA PARA TUBO MECANICO 1 1/2" HALF BALL END CAP MECHANICAL TUBE 1 1/2 " Ga. 12	12	NATURAL
ASH-0775	TAPA PARA TUBO MECANICO 1 1/4" HALF BALL END CAP MECHANICAL TUBE 1 1/4" Ga. 12	12	NATURAL
ASH-0776	TAPA PARA TUBO MECANICO 2" HALF BALL END CAP MECHANICAL TUBE 2" Ga. 12	12	NATURAL
ASH-0777	TAPA PARA TUBO MECANICO 2 1/2" HALF BALL END CAP MECHANICAL TUBE 2 1/2" Ga. 12	12	NATURAL
ASH-0778	TAPA PARA TUBO MECANICO 3" HALF BALL END CAP MECHANICAL TUBE 3" Ga. 12	12	NATURAL
ASH-0779	TAPA PARA TUBO MECANICO 4" HALF BALL END CAP MECHANICAL TUBE 4" Ga. 12	12	NATURAL

CODE	NAME	DIAMETER	THICKNESS	CAPACITY	LENGTH	WIDTH	FINISH
ASH-0502	RUEDA DE FIERRO VACIADO 4" DOBLE BALERO CAST IRON WHEEL "BOXED" 4" WITH BOX DOUBLE BEARING	4"	1 3/4"	150 lb.			NATURAL
ASH-0503	RUEDA DE FIERRO VACIADO "CON CAJA" 4" CAST IRON WHEEL 4" WITHOUT BOX	4"	0.134"	150 lb.	5"	3"	NATURAL
ASH-0504	RUEDA DE FIERRO VACIADO 6" DOBLE BALERO CAST IRON WHEEL "BOXED" 6" WITH BOX DOUBLE BEARING	6"	2 1/2"	200 lb.			NATURAL
ASH-0505	RUEDA DE FIERRO VACIADO "CON CAJA" 6" CAST IRON WHEEL 6" WITHOUT BOX	6"	0.134"	200 lb.	4 1/4"	7"	NATURAL

CODE	NAME	LENGTH	WIDTH	Ga	FINISH
ASH-0128	CAJA PARA RUEDA DE FIERRO VACIADO 4" BOX FOR 4" CAST IRON WHEEL 4"	3"	2 3/8"	12	NATURAL
ASH-0129	CAJA PARA RUEDA DE FIERRO VACIADO 6" BOX FOR 6" CAST IRON WHEEL 6"	4 1/4"	2 3/8"	12	NATURAL



ABASTECEDORA DE SOLDADURA Y HERRAJES S.A. DE C.V.  
 MIER Y NORIEGA No. 304 NTE. C.P. 67100 CD. GUADALUPE, N.L. MEXICO  
 Conmutador: (81) 83-54-83-45 Fax: (81) 83-54-83-45  
 admonventas@ashmex.com www.ashmex.com

ASH IMPORT & EXPORT LLC  
 601-E CEDAR AVE, SUITE E MC ALLEN, TX 78501 USA  
 PHONE/FAX : (956) 8004448 CELL PHONE: (956) 3880948  
 ashiellc@hotmail.com ashimportexport@gmail.com www.ashmex.com

# STEEL WHEEL U-GROOVE / RUEDA MAQUINADA EN REDONDO

CODE	NAME	DIAMETER	FINISH
<b>RUEDA CON CAJA / WITH BOX</b>			
ASH-0715	RUEDA MAQ.C/CAJA 2"X3/4" C/BAL.REF P/REDONDOS "BOXED" 2" X 3/4" WITH BOX AND BEARING	2"	TROPICALIZADO TROPICALIZED
ASH-0717	RUEDA MAQ.C/CAJA 2 1/2"X3/4" C/BAL.REF.P/REDONDOS "BOXED" 2 1/2" X 3/4" WITH BOX AND BEARING	2 1/2"	TROPICALIZADO TROPICALIZED
ASH-0716	RUEDA MAQ.C/CAJA 3"X3/4" C/BAL.REF.P/REDONDOS "BOXED" 3" X 3/4" WITH BOX AND BEARING	3"	TROPICALIZADO TROPICALIZED
ASH-0718	RUEDA MAQ.C/CAJA 3"X 1 1/2" C/BAL.REF.P/REDONDOS "BOXED" 3" X 1 1/2" WITH BOX AND BEARING	3"	TROPICALIZADO TROPICALIZED
<b>RUEDAS SIN CAJA / WITHOUT BOX</b>			
ASH-0722	RUEDA MAQ. 2"X 3/4" C/BALERO REF. P/REDONDOS 2" X 3/4" WITHOUT BOX AND BEARING	2"	TROPICALIZADO TROPICALIZED
ASH-0721	RUEDA MAQ. 3" X 3/4" C/BAL.REF.P/REDONDOS 3" X 3/4" WITHOUT BOX AND BEARING	3"	TROPICALIZADO TROPICALIZED
ASH-0719	RUEDA MAQ. 3" X 1 1/2" C/BAL.REF. P/REDONDOS 3" X 1 1/2" WITHOUT BOX AND BEARING	3"	TROPICALIZADO TROPICALIZED



CODE	NAME	DIAMETER	LENGTH	WIDTH	TICKNEES	CAPACITY
ASH-0516	RUEDA MAQUINADA CON CAJA 2" X 3/4" TROPICALIZADO STEEL WHEEL "BOXED" 2" X 3/4"	2"	2 3/4"	2"	1"	100 lb.
ASH-0530	RUEDA MAQUINADA CON CAJA 2 1/2" X 3/4" TROPICALIZADO STEEL WHEEL "BOXED" 2 1/2" X 3/4"	2 1/2"	3 3/4"	2 3/4"	1 1/8"	125 lb.
ASH-0517	RUEDA MAQUINADA CON CAJA 3" X 3/4" TROPICALIZADO STEEL WHEEL "BOXED" 3" X 3/4"	3"	3 1/2"	2 5/8"	1 1/4"	150 lb.
ASH-0891	RUEDA MAQ. 4" X1 3/4" C/BALERO TROPICALIZADO STEEL WHEEL 4" X1 3/4" WITHOUT BOX AND BEARING	4"			1 3/4"	

CODE	NAME	DIAMETER	LENGTH	WIDTH	THICKNESS	FINISH
ASH-0620	RUEDA MAQUINADA CON CAJA 3" X 1 1/2" TRABAJO PESADO STEEL WHEEL "BOXED" HEAVY DUTY 3"X1 1/2"WITH BOX DOUBLE BEARING	3"	3 1/4"	1 3/4"	1 1/2"	TROPICALIZADO TROPICALIZED
ASH-0625	RUEDA MAQUINADA DE ACERO 3" X 1 1/2" TRABAJO PESADO STEEL WHEEL HEAVY DUTY 3"X1 1/2" WITHOUT BOX DOUBLE BEARING	3"	3 1/4"	1 3/4"	1 1/2"	TROPICALIZADO TROPICALIZED
ASH-0658	CAJA PARA RUEDA MAQUINADA DE ACERO 3" X 1 1/2" TRABAJO PESADO BOX FOR HEAVY STEEL WHEEL 3" DOUBLE BEARING		2 5/8"	1 1/4"	1 1/2"	TROPICALIZADO TROPICALIZED
ASH-0892	RUEDA MAQ.C/CAJA 4" X1 3/4" C/BALERO TROPICALIZADO "BOXED" 4" X1 3/4 WITH BOX AND BEARING	4"			1 13/4"	TROPICALIZADO TROPICALIZED

CODE	NAME	LARGO	ANCHO	Ga	PESO
ASH-0514	CAJA PARA RUEDA DE ACERO 2" « BOX FOR STEEL WHEEL 2"	2"	2 1/2"	12	0.180 KG
ASH-0515	CAJA PARA RUEDA DE ACERO 2 1/2 Y 3" « BOX FOR STEEL WHEEL 2 1/2 and 3"	2 3/4"	3 3/4"	12	0.350 KG
ASH-0128	CAJA PARA RUEDA DE FIERRO VACIADO 4" « BOX FOR CASTING WHEEL FIERRO 4"	3"	2 3/8"	12	0.680 KG
ASH-0129	CAJA PARA RUEDA DE FIERRO VACIADO 6" « BOX FOR CASTING IRON WHEEL 6"	4 1/4"	2 3/8"	12	1.31 KG



**ABASTECEDORA DE SOLDADURA Y HERRAJES S.A. DE C.V.**  
 MIER Y NORIEGA No. 304 NTE. C.P. 67100 CD. GUADALUPE, N.L. MEXICO  
 Conmutador: (81) 83-54-83-45 Fax: (81) 83-54-83-45  
 admonventas@ashmex.com www.ashmex.com

**ASH IMPORT & EXPORT LLC**  
 601-E CEDAR AVE, SUITE E MC ALLEN, TX 78501 USA  
 PHONE/FAX : (956) 8004448 CELL PHONE: (956) 3880948  
 ashiellc@hotmail.com ashimportexport@gmail.com www.ashmex.com

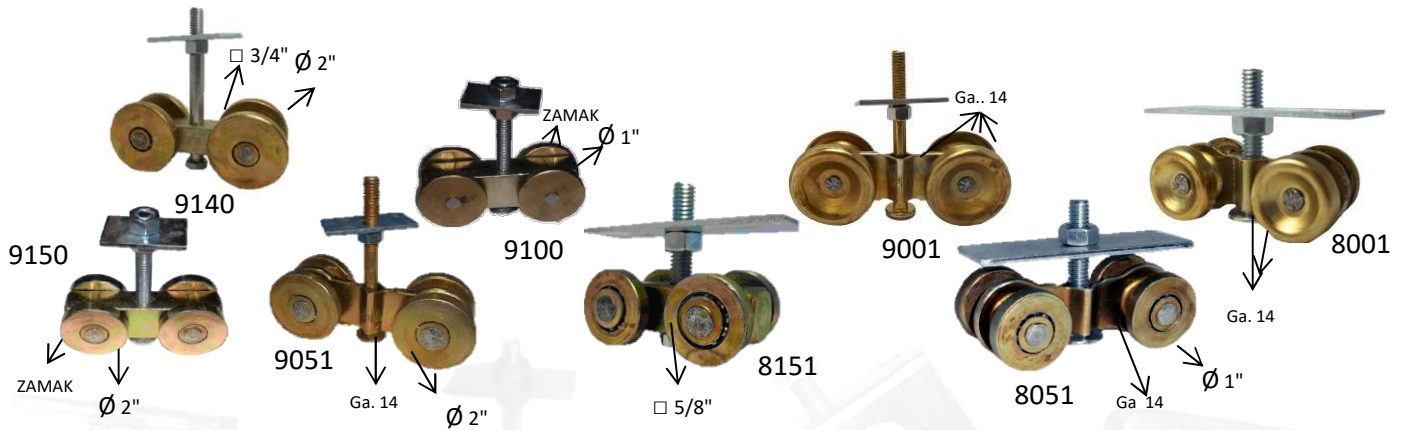

CODE	NAME	DIAMETER	LENGTH	WIDTH	CAPACITY	FINISH
ASH-0095	<b>CORREDERA 8000 ECONOMICA (PORTON LIVIANO)</b> TROLLEY 8000 SQUARE TRACK (ECONOMIC)	1"	2 1/2"	1 1/2"	66.13 lb	<b>TROPICALIZADO</b> TROPICALIZED
ASH-0197	<b>CORREDERA 8050 CUERPO TROQUELADO (PORTON LIVIANO)</b> TROLLEY 8050 SQUARE TRACK REINFORCED BODY	1"	3"	1 1/2"	110.23 lb	<b>TROPICALIZADO</b> TROPICALIZED
ASH-0150	<b>CORREDERA 8150 CUERPO REFORZADO (PORTON LIVIANO)</b> TROLLEY 8150 SQUARE TRACK 5/8" REINFORCED BODY	1"	2"	1 1/2"	110.23 lb	<b>TROPICALIZADO</b> TROPICALIZED
ASH-0096	<b>CORREDERA 9000 CUERPO TROQUELADO (PORTON PESADO)</b> TROLLEY 9000 SQUARE TRACK BEARING AND STEEL WHEEL	2"	5"	1 1/2"	110.23 lb	<b>TROPICALIZADO</b> TROPICALIZED
ASH-0098	<b>CORREDERA 9050 "4 RUEDAS" RUEDA SOLIDA (PORTON PESADO)</b> TROLLEY 9050 SQUARE TRACK "SOLID WHEEL"	2"	4 3/4"	1 1/2"	100 lb.	<b>TROPICALIZADO</b> TROPICALIZED
ASH-0099	<b>CORREDERA 9100 CUERPO DE ZAMAK RUEDA MAQUINADA</b> TROLLEY 9100 SQUARE TRACK "SOLID WHEEL BODY MACHINED"	1 1/2"	5"	1 1/2"	125 lb	<b>TROPICALIZADO</b> TROPICALIZED
ASH-0100	<b>CORREDERA 9150 "4 RUEDAS" CUERPO RECTANGULAR</b> TROLLEY 9150 SQUARE TRACK " BEARING AND SOLID WHEEL"	2"	5"	1 1/2"	125 lb.	<b>TROPICALIZADO</b> TROPICALIZED
ASH-0148	<b>CORREDERA 9250 2 RUEDAS PARA RIEL 1500 "PLACA LARGA"</b> TROLLEY 9250 2 WHEELS "LONG BASE" BEARING AND SOLID WHEEL	2"	5 1/2"	1 1/2"	75 lb.	<b>TROPICALIZADO</b> TROPICALIZED

## CASTOR "CAST IRON"

CODE	NAME	DIAMETER	WHEEL LOAD X PC	FITTING (mm)
ASHRO-0057	<b>RODAJA DE FIERRO 2" (PLACA FIJA) CON BUJE</b> 2" RIGID FITTING "BUSHING"	2"	88.18 LB	50 X 76
ASHRO-0055	<b>RODAJA DE FIERRO 2" (PLACA GIRATORIA) CON BUJE</b> 2" SWIVEL FITTING "BUSHING"	2"	88.18 LB	50 X 63
ASHRO-0053	<b>RODAJA DE FIERRO 3" (PLACA FIJA) CON BUJE</b> 3" RIGID FITTING "BUSHING"	3"	198.416 LB	65 X 127
ASHRO-0052	<b>RODAJA DE FIERRO 3" (PLACA GIRATORIA) CON BUJE</b> 3" SWIVEL FITTING "BUSHING"	3"	198.416 LB	85 X 108
ASHRO-0021	<b>RODAJA DE FIERRO 4" (PLACA FIJA) CON BALERO</b> 4" RIGID FITTING "BUSHING"	4"	286.600 LB	80 X 161
ASHRO-0019	<b>RODAJA DE FIERRO 4" (PLACA GIRATORIA) CON BALERO</b> 4 SWIVEL FITTING "BUSHING"	4"	286.600 LB	102 X 128
ASHRO-0022	<b>RODAJA DE FIERRO 6" (PLACA FIJA) CON BALERO</b> 6" RIGID FITTING "BUSHING"	6"	440.924 LB	97 X 158
ASHRO-0020	<b>RODAJA DE FIERRO 6" (PLACA GIRATORIA) CON BALERO</b> 6" SWIVEL FITTING "BUSHING"	6"	440.924 LB	145 X 162



**ABASTECEDORA DE SOLDADURA Y HERRAJES S.A. DE C.V.**  
 MIER Y NORIEGA No. 304 NTE. C.P. 67100 CD. GUADALUPE, N.L. MEXICO  
 Conmutador: (81) 83-54-83-45 Fax: (81) 83-54-83-45  
 admonventas@ashmex.com www.ashmex.com

**ASH IMPORT & EXPORT LLC**  
 601-E CEDAR AVE, SUITE E MC ALLEN, TX 78501 USA  
 PHONE/FAX : (956) 8004448 CELL PHONE: (956) 3880948  
 ashie LLC@hotmail.com ashimportexport@gmail.com www.ashmex.com

## CASTOR "RUBBER"



CODE	NAME	DIAMETER	WHEEL LOAD X PC	FITTING (mm)
ASHRO-0056	RODAJA DE HULE 2" (PLACA FIJA) CON BUJE 2" RIGID FITTING "BUSHING"	2"	66.138 LB	----
ASHRO-0054	RODAJA DE HULE 2" (PLACA GIRATORIA) CON BUJE 2" SWIVEL FITTING "BUSHING"	2"	66.138 LB	----
ASHRO-0050	RODAJA DE HULE 3" (PLACA FIJA) CON BUJE "RODAMEX" 3" RIGID FITTING "BUSHING"	3"	165.346 LB	65 X 127
ASHRO-0049	RODAJA DE HULE 3" (PLACA GIRATORIA) CON BUJE RODAMEX" 3" SWIVEL FITTING "BUSHING"	3"	165.346LB	85 X 108
ASHRO-0013	RODAJA DE HULE 4" (PLACA FIJA) CON BALERO 4" RIGID FITTING "BEARING"	4"	220.462 LB	80 X 161
ASHRO-0011	RODAJA DE HULE 4" (PLACA GIRATORIA) CON BALERO 4" SWIVEL FITTING "BEARING"	4"	220.462 LB	102 X 128
ASHRO-0014	RODAJA DE HULE 6" (PLACA FIJA) CON BALERO 6" RIGID FITTING "BEARING"	6"	330.693 LB	97 X 158
ASHRO-0012	RODAJA DE HULE 6" (PLACA GIRATORIA) CON BALERO 6" SWIVEL FITTING "BEARING"	6"	330.693 LB	145 X 162

## CASTOR "WHITE POLYETHYLENE"

CODE	NAME	WHEEL LOAD X PC	FITTING (mm)
ASHRO-0059	RODAJA DE POLIET BLANCO 3" PLACA GIRA. BAL.Y FRENO 3" SWIVEL FITTING "BEARING" "BRAKE"	286.60 LB	70 X 101
ASHRO-0179	RODAJA DE POLIET BLANCO 3" (PLACA FIJA Y BALERO) GALV. 3" SWIVEL FITTING "BEARING"		70 X 101
ASHRO-0061	RODAJA DE POLIET BLANCO 3" (PLACA FIJA Y BALERO) 3" RIGID FITTING "BEARING"	286.60 LB	63 X 110
ASHRO-0060	RODAJA DE POLIET BLANCO 4" (PLACA GIRA.BAL.Y FRENO) 4" SWIVEL FITTING "BEARING" "BRAKE"	352.73 LB	85 X 108
ASHRO-0075	RODAJA PLANA IND. D/POLIET BCO 4" PLACA GIRATORIA Y BALERO 4" SWIVEL FITTING "BEARING"		85 X 108
ASHRO-0062	RODAJA DE POLIET BLANCO 4" (PLACA FIJA Y BALERO) 4" RIGID FITTING "BEARING"	352.73 LB	80 X 161



## STEER ALUMINIUM WHEEL SOLID RUBBER TREADED RUEDA TIPO DIABLO



CODE	NAME	DIAMETER
ASHRD-0068	RUEDA TIPO DIABLO 6" RIN ALUMINIO BALERO INTERNO STEER ALUMINIUM WHEEL INTERNAL BEARING 6"	6"
ASHRD-0070	RUEDA TIPO DIABLO 7" RIN ALUMINIO BALERO INTERNO STEER ALUMINIUM WHEEL INTERNAL BEARING 7"	7"
ASHRD-0072	RUEDA TIPO DIABLO 8" RIN ALUMINIO BALERO INTERNO STEER ALUMINIUM WHEEL INTERNAL BEARING 8"	8"
ASHRD-0074	RUEDA TIPO DIABLO 9" RIN ALUMINIO BALERO INTERNO STEER ALUMINIUM WHEEL INTERNAL BEARING 9"	9"

# STEER WHEEL SOLID RUBBER TREADED



CODE	NAME	DIAMETER
ASHRD-0039	<b>RUEDA TIPO DIABLO 4" X 5/8" 1 BALERO 6203</b> STEER WHEEL 4" X 5/8" "1 BEARING"	4"
ASHRD-0051	<b>RUEDA TIPO DIABLO 5" X 5/8" 1 BALERO 6203</b> STEER WHEEL 5" X 5/8" "1 BEARING"	5"
ASHRD-0042	<b>RUEDA TIPO DIABLO 6" X 5/8" 1 BALERO 6203</b> STEER WHEEL 6" X 5/8" "1 BEARING"	6"
ASHRD-0043	<b>RUEDA TIPO DIABLO 6" X 5/8" 2 BALERO 6203</b> STEER WHEEL 6" X 5/8" 2 BEARING"	6"
ASHRD-0044	<b>RUEDA TIPO DIABLO 7" X 5/8" 2 BALERO 6203</b> STEER WHEEL 7" X 5/8" 2 BEARING"	7"
ASHRD-0045	<b>RUEDA TIPO DIABLO 8" X 5/8" 2 BALERO 6203</b> STEER WHEEL 8" X 5/8" "2 BEARING"	8"
ASHRD-0046	<b>RUEDA TIPO DIABLO 9" X 5/8" 2 BALERO 6203</b> STEER WHEEL 9" X 5/8" "2 BEARING"	9"
ASHRD-0047	<b>RUEDA TIPO DIABLO 10" X 5/8" 2 BALERO 6203</b> STEER WHEEL 10" X 5/8" "2 BEARING"	10"

CODE	NAME	LENGTH	FINISH
VTTO-0016	<b>VARILLA ROSCADA ( 6.35MM.)1/4" 1 MTO.</b> THREADED ROD 1/4"	3.3 FT	<b>GALVANIZADO</b> GALVANIZED
VTTO-0017	<b>VARILLA ROSCADA ( 7.93MM.)5/16" 1 MTO.</b> THREADED ROD 5/16"	3.3 FT	<b>GALVANIZADO</b> GALVANIZED
VTTO-0018	<b>VARILLA ROSCADA ( 9.52MM.)3/8" 1 MTO.</b> THREADED ROD 3/8"	3.3 FT	<b>GALVANIZADO</b> GALVANIZED
VTTO-0020	<b>VARILLA ROSCADA (12.7MM.)1/2" 1 MTO.</b> THREADED ROD 1/2"	3.3 FT	<b>GALVANIZADO</b> GALVANIZED
VTTO-0021	<b>VARILLA ROSCADA (15.87MM.)5/8" 1 MTO.</b> THREADED ROD 5/8"	3.3 FT	<b>GALVANIZADO</b> GALVANIZED
VTTO-0022	<b>VARILLA ROSCADA (19.05MM.)3/4" 1 MTO.</b> THREADED ROD 3/4"	3.3 FT	<b>GALVANIZADO</b> GALVANIZED
VTTO-0030	<b>VARILLA ROSCADA (25.4MM.)1" 1 MTO.</b> THREADED ROD 1"	3.3 FT	<b>GALVANIZADO</b> GALVANIZED
VTTO-0027	<b>VARILLA ROSCADA 3M X 1/4"</b> THREADED ROD 1/4"	10 FT	<b>GALVANIZADO</b> GALVANIZED
VTTO-0031	<b>VARILLA ROSCADA 3M X 5/16"</b> THREADED ROD 5/16"	10 FT	<b>GALVANIZADO</b> GALVANIZED
VTTO-0035	<b>VARILLA ROSCADA 3M X 3/8"</b> THREADED ROD 3/8"	10 FT	<b>GALVANIZADO</b> GALVANIZED
VTTO-0037	<b>VARILLA ROSCADA 3M X 1/2"</b> THREADED ROD 1/2"	10 FT	<b>GALVANIZADO</b> GALVANIZED
VTTO-0038	<b>VARILLA ROSCADA (15.87MM.)5/8" 3 MTO.</b> THREADED ROD 5/8"	10 FT	<b>GALVANIZADO</b> GALVANIZED
VTTO-0039	<b>VARILLA ROSCADA 19.05MM.)3/4" 3 MTO.</b> THREADED ROD 3/4"	10 FT	<b>GALVANIZADO</b> GALVANIZED
VTTO-0041	<b>VARILLA ROSCADA (25.4MM.)1" 3 MTO.</b> THREADED ROD 1"	10 FT	<b>GALVANIZADO</b> GALVANIZED



**ABASTECEDORA DE SOLDADURA Y HERRAJES S.A. DE C.V.**  
 MIER Y NORIEGA No. 304 NTE. C.P. 67100 CD. GUADALUPE, N.L. MEXICO  
 Conmutador: (81) 83-54-83-45 Fax: (81) 83-54-83-45  
 admonventas@ashmex.com www.ashmex.com

**ASH IMPORT & EXPORT LLC**  
 601-E CEDAR AVE, SUITE E MC ALLEN, TX 78501 USA  
 PHONE/FAX : (956) 8004448 CELL PHONE: (956) 3880948  
 ashiehc@hotmail.com ashimportexport@gmail.com www.ashmex.com





ASH IMPORT & EXPORT LLC



Decorative Accessories  
Forgings and Castings

# STEEL PUNCHED

CODE	NAME	LENGTH	LENGTH	WIDTH	THICKNESS	THICKNESS	FINISH
						MM	
ASFC-0400	SOLERA PERFORADA PARA [ ] 1/2" 12CM STEEL PUNCHED STRUCTURAL BAR HOLE SQUARE 1/2" (MILL FINISH)	10 FT	3.048 M	1 1/4"	3/16"	0.187	NATURAL
ASH-0686	SOLERA PERFORADA PARA [ ] 3/4" 12CM STEEL PUNCHED STRUCTURAL BAR HOLE SQUARE 3/4" (MILL FINISH)	10 FT	3.048 M	1 1/4"	3/16"	0.187	NATURAL
ASFC-0402	SOLERA PERFORADA PARA [ ] 5/8" 12CM STEEL PUNCHED STRUCTURAL BAR HOLE SQUARE 5/8" (MILL FINISH)	10 FT	3.048 M	1 1/4"	3/16"	0.187	NATURAL

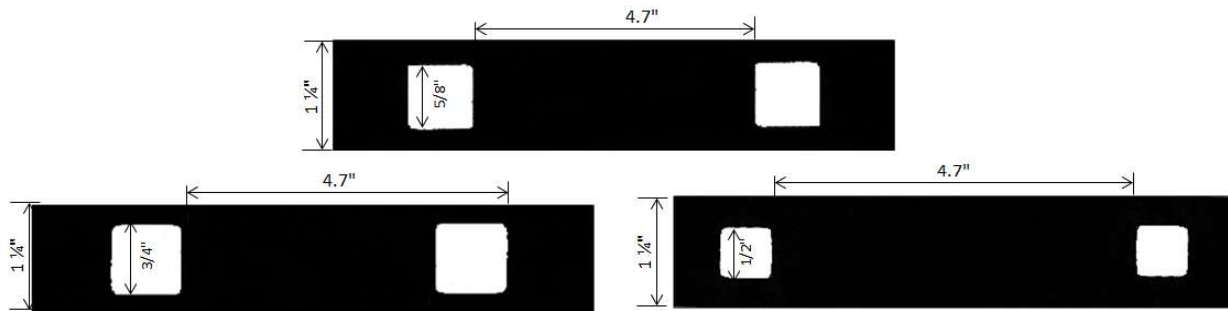

ABASTECEDORA DE SOLDADURA Y HERRAJES S.A. DE C.V.  
 MIER Y NORIEGA No. 304 NTE. C.P. 67100 CD. GUADALUPE, N.L. MEXICO  
 Conmutador: (81) 83-54-83-45 Fax: (81) 83-54-83-45  
 admonventas@ashmex.com www.ashmex.com

ASH IMPORT & EXPORT LLC  
 601-E CEDAR AVE, SUITE E MC ALLEN, TX 78501 USA  
 PHONE/FAX : (956) 8004448 CELL PHONE: (956) 3880948  
 ashiellc@hotmail.com ashimportexport@gmail.com www.ashmex.com

# FORGED STEEL

CODE	NAME	FINISH	ROD	DIAMETER	LENGTH	WIDTH	THICKNESS
ASFC-0001	FORJA C-01 12 X 17 CM. [ ] 1/2" 0.420KG. FORGED STEEL [ ] BAR SCROLL "A-01"	NATURAL	*SQUARE		12"	6 3/4"	1/2"
ASFC-0002	FORJA CUAD.1/2" 12 X 21CM. "ASH-2" FORGED STEEL [ ] BAR SCROLL "A-02"	NATURAL	*SQUARE		8 3/4"	4 3/4"	1/2"
ASFC-0007	FORJA CUAD.1/2" 12 X 37.5 CM. "ASH-7" S/TORSION FORGED STEEL [ ] BAR SCROLL "A-07"	NATURAL	*SQUARE		14 3/4"	4 1/2"	1/2"
ASFC-0008	FORJA CUAD.1/2" 12 X 33 CM. "ASH-8" S/TORSION PE FORGED STEEL [ ] BAR SCROLL "A-08"	NATURAL	*SQUARE		12 1/4"	4 3/4"	1/2"
ASFC-0009	FORJA CUAD.1/2" 12 X 63.5 CM. "ASH-9" FORGED STEEL [ ] BAR SCROLL "A-09"	NATURAL	*SQUARE		25"	4 3/4"	1/2"
ASFC-0010	FORJA CUAD.1/2" 12 X 63.5 CM. "ASH-10" FORGED STEEL [ ] BAR SCROLL "A-10"	NATURAL	*SQUARE		24 3/4"	4 3/4"	1/2"
ASFC-0011	FORJA CUAD.1/2" 12 X 63.5 CM. "ASH-11" FORGED STEEL [ ] BAR SCROLL "A-11"	NATURAL	*SQUARE		24 3/4"	4 3/4"	1/2"
ASFC-0012	FORJA CUAD.1/2" 11 X 49 CM. A 15 X 49 CM "ASH-12" FORGED STEEL [ ] BAR SCROLL "A-12"	NATURAL	*SQUARE		19"	6 1/16"	1/2"
ASFC-0013	FORJA CUAD.1/2" 12 X 33 CM. "ASH-13" FORGED STEEL [ ] BAR SCROLL "A-13"	NATURAL	*SQUARE		13"	4 1/2"	1/2"
ASFC-0014	FORJA CUAD.1/2" 12 X 32.5 CM. "ASH-14" FORGED STEEL [ ] BAR SCROLL "A-14"	NATURAL	*SQUARE		12"	4 3/4"	1/2"
ASFC-0015	FORJA A-15 12 X 28 CM. [ ] 1/2" SIN TORSION FORGED STEEL [ ] BAR SCROLL "A-15"	NATURAL	*SQUARE		10 3/4"	4 1/4"	1/2"
ASFC-0016	FORJA CUAD.1/2" 12 X 37.5 CM. "ASH-16" FORGED STEEL [ ] BAR SCROLL "A-16"	NATURAL	*SQUARE		14"	4 3/4"	1/2"
ASFC-0619	FORJA B-02 21 X 12 CM FORGED STEEL [ ] BAR SCROLL "B-02"	NATURAL	*SQUARE		8 1/2"	5 1/2"	1/2"
ASFC-0077	FORJA CUAD.1/2" 12 X 37.5 CM. "ASH-7" FORGED STEEL [ ] BAR SCROLL "A-07T" TWISTED	NATURAL	*SQUARE		14 3/4"	4 1/2"	1/2"
ASFC-0088	FORJA CUAD.1/2" 12 X 33 CM. "ASH-8" C/TORSION FORGED STEEL [ ] BAR SCROLL "A-08T" TWISTED	NATURAL	*SQUARE		12 1/4"	4 3/4"	1/2"
ASFC-1515	FORJA CUAD.1/2" 12 X 28 CM. "ASH-15" C/TORSION FORGED STEEL [ ] BAR SCROLL "A-15T" TWISTED	NATURAL	*SQUARE		11"	4 1/4"	1/2"
ASFC-0005	FORJA CUAD.1/2" "O" ARO DIAM.12CM. A-05) FORGED STEEL [ ] BAR RING "A-05" SQ	NATURAL	*SQUARE	3 3/4"	4 3/4"	4 3/4"	1/2"
ASFC-0006	FORJA CUAD.1/2" "O" ARO DIAM.16CM. (A-06) FORGED STEEL [ ] BAR RING "A-06" SQ	NATURAL	*SQUARE	5 3/8"	6 5/16"	6 5/16"	1/2"
ASFR-0003	FORJA ARO C-3 12 CM REDONDO DE 1/2" FORGED STEEL Ø BAR "RING" "A-03" CR.	NATURAL	*ROUND	3 3/4"	4 3/4"	4 3/4"	1/2"
ASFR-0004	FORJA AROC-4 16 CM REDONDO DE 1/2" FORGED STEEL Ø BAR "RING" "A-04" CR.	NATURAL	*ROUND	5 1/4"	6 3/16"	6 3/16"	1/2"
ASFC-0512	FORJA CUAD.1/2" "U" CHICA 12 X 12 CM. FORGED STEEL [ ] BAR "U" "A-5C"	NATURAL	*SQUARE		4 3/4"	4 3/4"	1/2"
ASFC-0620	ARO DE PERFIL TUBULAR DE 1/2 [ ] "CAL 16 DE 4 " RING TUBULAR PROFILE [ ] 16 Ga 4" SQ	NATURAL	*SQUARE	4"	4"	4"	1/2"
ASFC-0621	ARO DE PERFIL TUBULAR DE 1/2 [ ] "CAL 16 DE 4 1/2" RING TUBULAR PROFILE [ ] 16 Ga 4 1/2" SQ	NATURAL	*SQUARE	4 1/2"	4 1/2"	4 1/2"	1/2"
ASFC-0622	ARO DE PERFIL TUBULAR DE 1/2 [ ] "CAL 16 DE 5 " RING TUBULAR PROFILE [ ] 16 Ga 5" SQ	NATURAL	*SQUARE	5"	5"	5"	1/2"
ASFC-0518	FORJA CUAD.1/2" "U" GRANDE 12 X 18 CM. FORGED STEEL [ ] BAR "U" "A-05G"	NATURAL	*SQUARE		7 1/2"	4 3/4"	1/2"

ABASTECEDORA DE SOLDADURA Y HERRAJES S.A. DE C.V.  
 MIER Y NORIEGA No. 304 NTE. C.P. 67100 CD. GUADALUPE, N.L. MEXICO  
 Conmutador: (81) 83-54-83-45 Fax: (81) 83-54-83-45  
 admonventas@ashmex.com www.ashmex.com

ASH IMPORT & EXPORT LLC  
 601-E CEDAR AVE, SUITE E MC ALLEN, TX 78501 USA  
 PHONE/FAX : (956) 8004448 CELL PHONE: (956) 3880948  
 ashiecll@hotmail.com ashimportexport@gmail.com www.ashmex.com



**ASFC-0001**

\*SQUARE ROD



**ASFC-0002**

\*SQUARE ROD



**ASFC-0007**

\*SQUARE ROD



**ASFC-0009**

\*SQUARE ROD



**ASFC-0010**

\*SQUARE ROD



**ASFC-0011**

\*SQUARE ROD



**ASFC-0008**

\*SQUARE ROD



**ASFC-0012**

\*SQUARE ROD



**ASFC-0013**

\*SQUARE ROD



**ASFC-0014**

\*SQUARE ROD



**ASFC-0015**

\*SQUARE ROD



**ASFC-0016**

\*SQUARE ROD



**ASFC-0088**

\*SQUARE ROD



**ASFC-1515**

\*SQUARE ROD



**ASFC-0077**

\*SQUARE ROD



**ASFC-0006**



**ASFC-0005**

\*SQUARE ROD



**ASFC-0004**



**ASFC-0003**

\*ROUND ROD



**ASFC-0518**



**ASFC-0512**

\*SQUARE ROD

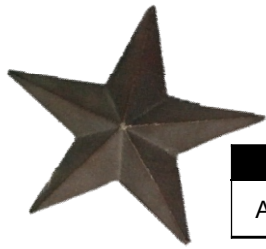

# CAST IRON

CODE	NAME	LENGTH	WIDTH	FINISH
ASHF-0051	PANTALLA FO.VO. "ESTRELLA 3D« CAST IRON "3D STAR"	5"	5"	NATURAL

CODE	NAME	LENGTH	WIDTH	FINISH
ASHF-0052	PANTALLA FO.VO. "ESTRELLA C/AGUJERO CHICA" CAST IRON "SMALL STAR" HOLED	3"	3"	NATURAL
ASHF-0053	PANTALLA FO.VO. "ESTRELLA C/AGUJERO MEDIANA« CAST IRON "MEDIUM STAR " HOLED	8 1/2"	8 1/2"	NATURAL
ASHF-0056	PANTALLA FO.VO. "ESTRELLA C/AGUJERO GRANDE" CAST IRON "LARGE STAR" HOLED	4"	4"	NATURAL

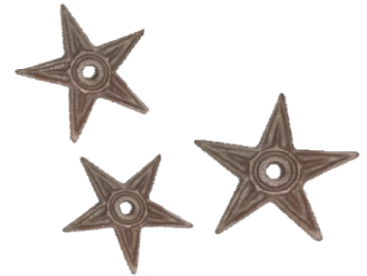

CODE	NAME	LENGTH	WIDTH	FINISH
ASHF-0025	PANTALLA FO.VO. "ESTRELLA CHICA DOBLE" CAST IRON "DOUBLE SMALL STAR"	3 3/4"	3 3/4"	NATURAL
ASHF-0039	PANTALLA FO.VO. "ESTRELLA MEDIANA DOBLE« CAST IRON "DOUBLE MEDIUM STAR«	8 1/2"	8 1/2"	NATURAL
ASHF-0054	PANTALLA FO.VO. "ESTRELLA GRANDE DOBLE« CAST IRON "DOUBLE LARGE STAR"	5"	5"	NATURAL

CODE	NAME	LENGTH	WIDTH	FINISH
ASHF-0021	PANTALLA FO.VO. "CABALLO DERECHA« CAST IRON "RIGTH HORSE"	6"	3 3/4"	NATURAL
ASHF-0022	PANTALLA FO.VO. "CABALLO IZQUIERDA CAST IRON "LEFT HORSE"	6"	3 3/4"	NATURAL

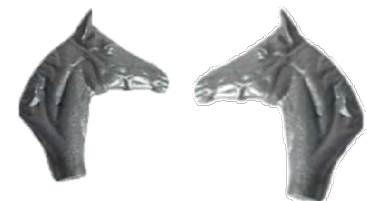

CODE	NAME	LENGTH	WIDTH	FINISH
ASHF-0019	PANTALLA FO.VO. "BOTA DERECHA« CAST IRON "RIGTH BOOT"	4 1/2"	4 1/2"	NATURAL
ASHF-0020	PANTALLA FO.VO. "BOTA IZQUIERDA« CAST IRON "LEFT BOOT"	4 1/2"	4 1/2"	NATURAL

CODE	NAME	LENGTH	WIDTH	FINISH
ASHF-0017	PANTALLA FO.VO. "TORO« CAST IRON "LONGHORN"	1 FT	3 3/4"	NATURAL



CODE	NAME	LENGTH	WIDTH	FINISH
ASHF-0018	PANTALLA FO.VO. "HERRADURA« CAST IRON "HORSESHOE"	4 3/8"	1 5/8"	NATURAL

CODE	NAME	DIAMETER	FINISH
ASHF-0050	PANTALLA FO.VO. "ESTRELLA TEXAS« CAST IRON "TEXAS STAR"	8 1/2"	NATURAL



CODE	NAME	DIAMETE R	FINISH
ASHF-0337	ESTRELLA CON CIRCULO 4" CAST IRON "STAR WITH CIRCLE"	4"	NATURAL

ABASTECEDORA DE SOLDADURA Y HERRAJES S.A. DE C.V.  
 MIER Y NORIEGA No. 304 NTE. C.P. 67100 CD. GUADALUPE, N.L. MEXICO  
 Conmutador: (81) 83-54-83-45 Fax: (81) 83-54-83-45  
 admonventas@ashmex.com www.ashmex.com

ASH IMPORT & EXPORT LLC  
 601-E CEDAR AVE, SUITE E MC ALLEN, TX 78501 USA  
 PHONE/FAX : (956) 8004448 CELL PHONE: (956) 3880948  
 ashiellc@hotmail.com ashimportexport@gmail.com www.ashmex.com

# LASER KEY HOLDER

CODE	NAME	LENGTH	WIDTH	FINISH
ASLA-0001	PORTA LLAVES EN LASER VENADO C/PALMA PALM TREE AN DEER"	13"	14"	NEGRO MATE MATTE BLACK
ASLA-0002	PORTA LLAVES EN LASER VENADO "DEER"	10"	14"	NEGRO MATE MATTE BLACK
ASLA-0003	PORTA LLAVES EN LASER CABALLOS "HORSES"	9 3/4"	13"	NEGRO MATE MATTE BLACK
ASLA-0004	PORTA LLAVES EN LASER YEGUA Y POTRILL "HORSE AND COLT"	10"	14"	NEGRO MATE MATTE BLACK
ASLA-0005	PORTA LLAVES EN LASER TORO "BULL"	13"	13"	NEGRO MATE MATTE BLACK
ASLA-0006	PORTA LLAVES EN LASER COYOTE "COYOTE"	11"	13"	NEGRO MATE MATTE BLACK
ASLA-0007	PORTA LLAVES EN LASER JINETE LAZANDO "HORSE RIDER LASSO "	6"	14"	NEGRO MATE MATTE BLACK
ASLA-0008	PORTA LLAVES EN LASER JINETE CUIDANDO "COWBOY"	6 1/2"	13"	NEGRO MATE MATTE BLACK
ASLA-0009	PORTA LLAVES EN LASER JINETE SALTANDO "JUMPING RIDER"	7"	10"	NEGRO MATE MATTE BLACK
ASLA-0010	PORTA LLAVES EN LASER JINETE CORTADO "RIDER AND CALF"	7 1/4"	13"	NEGRO MATE MATTE BLACK
ASLA-0011	PORTA LLAVES EN LASER JINETE DOMANDO "BREAK IN RIDER"	11 1/2"	9 1/2"	NEGRO MATE MATTE BLACK
ASLA-0012	PORTA LLAVES EN LASER 7 JINETES "7 HORSE RIDERS"	7 1/4"	14"	NEGRO MATE MATTE BLACK
ASLA-0013	PORTA LLAVES EN LASER MARLBORO« MARLBORO"	14"	7"	NEGRO MATE MATTE BLACK
ASLA-0014	PORTA LLAVES EN LASER JINETE SOLITARIO "LONE RIDER"	15"	15"	NEGRO MATE MATTE BLACK
ASLA-0015	PORTA LLAVES EN LASER 5 JINETES BARD "5 RIDERS"	6"	13"	NEGRO MATE MATTE BLACK
ASLA-0016	PORTA LLAVES EN LASER JINETE RODEO "RODEO "	7"	1 FT	NEGRO MATE MATTE BLACK
ASLA-0017	PORTA LLAVES EN LASER PAPALOTE "WINDMILL"	15"	18"	NEGRO MATE MATTE BLACK
ASLA-0018	PORTA LLAVES EN LASER AGUILA "EAGLE"	15"	18"	NEGRO MATE MATTE BLACK
ASLA-0023	PORTA LLAVES EN LASER ROBALO "FISH"	10"	13"	NEGRO MATE MATTE BLACK
ASLA-0024	PORTA LLAVES EN LASER PATOS "DUCKS"	10"	14"	NEGRO MATE MATTE BLACK
ASLA-0029	PORTA LLAVES EN LASER LAZANDO TORO "HORSE RIDER BULL LASSO"	14"	13 1/2"	NEGRO MATE MATTE BLACK
ASLA-0031	PORTA LLAVES EN LASER VENADOS "DEERS"	7 1/2"	13"	NEGRO MATE MATTE BLACK
ASLA-0033	PORTA LLAVES EN LASER TEXAS "TEXAS"	5"	13"	NEGRO MATE MATTE BLACK

\*LASER KEYHOLDER IN BAKED PAINT

ABASTECEDORA DE SOLDADURA Y HERRAJES S.A. DE C.V.  
 MIER Y NORIEGA No. 304 NTE. C.P. 67100 CD. GUADALUPE, N.L. MEXICO  
 Conmutador: (81) 83-54-83-45 Fax: (81) 83-54-83-45  
 admonventas@ashmex.com www.ashmex.com

ASH IMPORT & EXPORT LLC  
 601-E CEDAR AVE, SUITE E MC ALLEN, TX 78501 USA  
 PHONE/FAX : (956) 8004448 CELL PHONE: (956) 3880948  
 ashiellc@hotmail.com ashimportexport@gmail.com www.ashmex.com





**ASLA-0001**



**ASLA-0002**



**ASLA-0003**

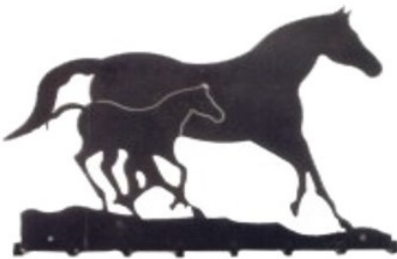

**ASLA-0004**



**ASLA-0005**



**ASLA-0006**



**ASLA-0007**



**ASLA-0008**



**ASLA-0009**



**ASLA-0010**



**ASLA-0011**



**ASLA-0012**



**ASLA-0013**



**ASLA-0014**



**ASLA-0015**



**ASLA-0016**



**ASLA-0017**



**ASLA-0018**



**ASLA-0023**



**ASLA-0024**



**ASLA-0029**



**ASLA-0031**



**ASLA-0033**

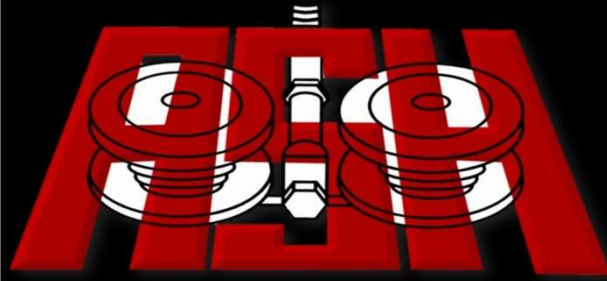

ASH IMPORT & EXPORT LLC



Expanded  
Metal

# EXPANDED GRILL METAL

TELA PARA ASADOR TIPO "G"

"G" HEAVY DUTY EXPANDED GRILL METAL  
TYPE G <> 0.875" X 1.62" (PR)

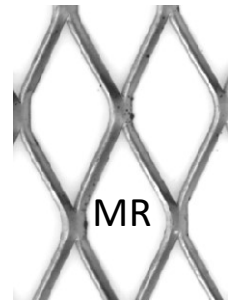
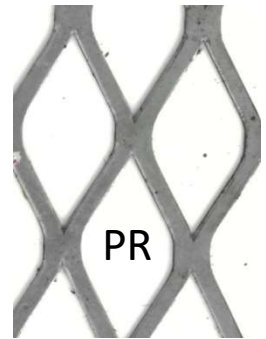

CODE	NAME	LENGTH	WIDTH	Ga	FINISH
ASHT-0314	G-9 PR ST. 2.5	4 FT	2 FT.	9	NATURAL
R O L L / R O L L O					
ASHT-0004	G-14MR ST.2.5	36.08 FT	3 FT	14	NATURAL
ASHT-0072	G-14PR ST.2.5	36.08 FT	3 FT	14	NATURAL
ASHT-0073	G-16PR ST.2.5	36.08 FT	3 FT	16	NATURAL
ASHT-0074	G-18PR ST.2.5	36.08 FT	3 FT	18	NATURAL

CODE	NAME	LENGTH	WIDTH	Ga	FINISH
ASHT-0306	H-14 PR STAINLESS STEEL ST.2.6 2 X 4 FT 14 Ga SHEET	4 FT	2 FT	14	NATURAL
ASHT-0331	J-14 PR STAINLESS STEEL ST.2.6 2 X 4 FT 14 Ga SHEET	4 FT	2 FT	14	NATURAL

## MOSQUI-RED CAL 26 EXPANDED METAL MOSQUITO MESH

CODE	NAME	LENGTH	WIDTH
ASHT-0053	MOSQ-26 ST0.5 3 X 7 FT. SHEET GALVANIZED	7 FT	3 FT
ASHT-0011	MOSQ-26 ST0.5 3 X 7 FT. SHEET BLACK	7 FT	3 FT

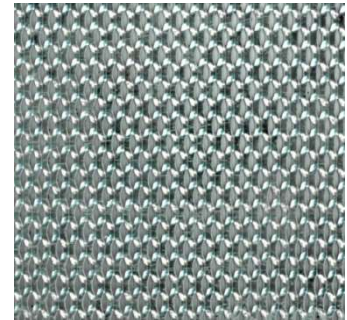

## METALETA GALVANIZADA EXPANDED METAL LATH MESH "GPG"

CODE	NAME	LENGTH	WIDTH
ASHT-0309	EXPANDED METAL LATH MESH	7 FT	3 FT

TELA TIPO D (PAJARERA)

"D" EXPANDED AVIARY METAL MESH  
TYPE D <> 0.476" X 0.8740" (PR)

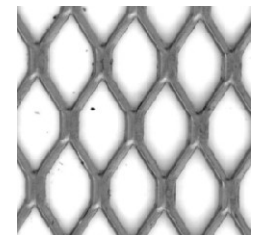

CODE	NAME	LENGTH	WIDTH	Ga	FINISH
ASHT-0254	D-18PR ST.1.5 36 FT. ROLL	36.08 FT	3 FT	18	NATURAL

ABASTECEDORA DE SOLDADURA Y HERRAJES S.A. DE C.V.  
MIER Y NORIEGA No. 304 NTE. C.P. 67100 CD. GUADALUPE, N.L. MEXICO  
Conmutador: (81) 83-54-83-45 Fax: (81) 83-54-83-45  
admonventas@ashmex.com www.ashmex.com

ASH IMPORT & EXPORT LLC  
601-E CEDAR AVE, SUITE E MC ALLEN, TX 78501 USA  
PHONE/FAX : (956) 8004448 CELL PHONE: (956) 3880948  
ashiellc@hotmail.com ashimportexport@gmail.com www.ashmex.com

**“E” TELA PARA MECEDORA**  
**“E” EXPANDED ROCKET CHAIR METAL MESH**  
**TYPE E <> 0.575" X 1.22" (PR)**

CODE	NAME	LENGTH	WIDTH	Ga	FINISH
ASHT-0211	E-18PR ST.2.0 ROLL	36.08 FT	3 FT	18	NATURAL
ASHT-0082	E-20PR ST.2.0 ROLL	36.08 FT	3 FT	20	NATURAL
ASHT-0054	E-22PR ST.2.0 ROLL	36.08 FT	3 FT	22	NATURAL

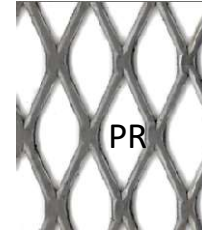

**METAL –RED (PLA-26)**



CODE	NAME	LENGTH	WIDTH	Ga	FINISH
ASHT-0084	PLA-26 ST.600 22 MTS ROLL	72 FT	3 FT	26	NATURAL
ASHT-0083	PLA-26 ST.500 22 MTS ROLL	72 FT	3 FT	26	NATURAL

**TELA PARA ASADOR TIPO “J”**  
**“J” EXPANDED GRILL METAL MESH**

TYPE J <> 1.501" X 2.75"(PR) <> 1.332" X 2.75" (MR)

CODE	NAME	LENGTH	WIDTH	Ga	FINISH
ASHT-0307	J-10PR ST.3	8 FT.	3 FT	10	NATURAL
ASHT-0300	J-12MR ST.3	4 FT.	3 FT	12	NATURAL
ROLL / ROLLO					
ASHT-0304	J-10PR ST.3	36.08 FT	3 FT	10	NATURAL
ASHT-0196	J-10MR ST.3	36.08 FT	3 FT	10	NATURAL
ASHT-0238	J-12PR ST.3	36.08 FT	3 FT	12	NATURAL
ASHT-0194	J-12MRST.3	36.08 FT	3 FT	12	NATURAL

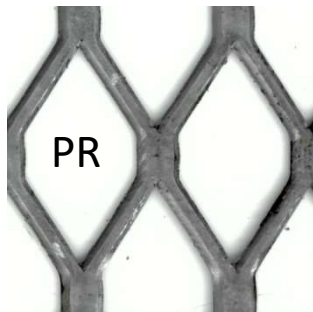
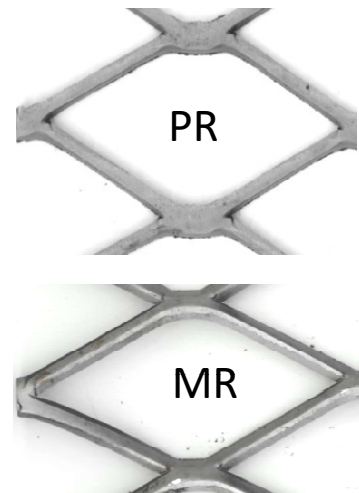

**TELA PARA ASADOR TIPO “H”**  
**“H” EXPANDED GRILL METAL MESH**  
**TYPE H <> 1.062" X 2" (PR) <> 0.937" X 2" (MR)**

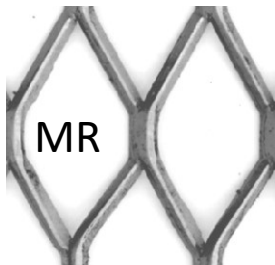

CODE	NAME	LENGTH	WIDTH	Ga	FINISH	\$
ASHT-0302	H-10MR ST.3	8 FT.	3 FT	10	NATURAL	\$ 46.47
ASHT-0303	H-10PR ST.3	8 FT.	3 FT	10	NATURAL	\$ 42.92
ASHT-0311	H-10PR ST.3	4 FT.	3 FT	10	NATURAL	\$ 19.30
ASHT-0310	H-10MR ST.3	4 FT.	3 FT	10	NATURAL	\$ 20.77
ROLL / ROLLO						
ASHT-0009	H-12MR ST.3	36.08 FT	3 FT	12	NATURAL	\$ 162.67
ASHT-0230	H-12PR ST.3	36.08 FT	3 FT	12	NATURAL	\$ 162.67
ASHT-0052	H-14MR ST.3	36.08 FT	3 FT	14	NATURAL	\$ 136.19
ASHT-0076	H-14PR ST.3	36.08 FT	3 FT	14	NATURAL	\$ 136.19



ASH IMPORT & EXPORT LLC



Fences and arrows  
products



CODE	NAME	FINISH	LENGTH
ASH-0415	PUNTASH D/SEG. 1 MTO. "MAGUEY« FENCE SPIKE BAR "MAGUEY"	NEGRO BLACK	39"



CODE	NAME	LENGTH	WIDTH	WEIGHT LB	Ga	FINISH
ASH-0157	PUNTA DE LAMINA TROQ. COLONIAL DOBLE ARROW "COLONIAL" DOUBLE	2 3/4"	2"	0.07	18	NATURAL
ASH-0182	PUNTA DE LAMINA TROQ. COLONIAL SENCILLA ARROW "COLONIAL" SINGLE	2 3/4"	2"	0.07	18	NATURAL

CODE	NAME	LENGTH	WIDTH	WEIGHT LB	Ga	FINISH
ASH-0183	PUNTA DE LAMINA TROQ. CUPIDO DOBLE ARROW "CUPID" DOUBLE	2 3/4"	1 1/2"	0.07	18	NATURAL
ASH-0184	PUNTA DE LAMINA TROQ. CUPIDO SECILLA ARROW "CUPID" SINGLE	2 3/4"	1 1/2"	0.07	18	NATURAL



CODE	NAME	LENGTH	WIDTH	WEIGHT LB	FINISH
ASH-0185	PUNTA DE LAMINA TROQ. T/DISNEY DOBLE ARROW "DISNEY" DOUBLE	4"	1 3/4"	0.07	NATURAL
ASH-0186	PUNTA DE LAMINA TROQ. T/DISNEY SENCILLA ARROW "DISNEY" SINGLE	4"	1 3/4"	0.07	NATURAL

CODE	NAME	LENGTH	WIDTH	WEIGHT LB	FINISH
ASH-0188	PUNTA ORNAMENTAL EN SOLERA "FLOR DE LIZ" ARROW ORNAMENTAL "FLOR DE LIZ"	4 1/4"	3"	0.176	NATURAL
ASH-0190	PUNTA ORNAMENTAL EN SOLERA "NAVE " ARROW ORNAMENTAL "NAVE "	4 1/4"	3"	0.176	NATURAL
ASH-0189	PUNTA ORNAMENTAL EN SOLERA "LANZA " ARROW ORNAMENTAL "LANZA "	4 1/4"	11/4"	0.110	NATURAL



ABASTECEDORA DE SOLDADURA Y HERRAJES S.A. DE C.V.

MIER Y NORIEGA No. 304 NTE. C.P. 67100 CD. GUADALUPE, N.L. MEXICO

Conmutador: (81) 83-54-83-45 Fax: (81) 83-54-83-45

admonventas@ashmex.com www.ashmex.com

ASH IMPORT & EXPORT LLC

601-E CEDAR AVE, SUITE E MC ALLEN, TX 78501 USA

PHONE/FAX : (956) 8004448 CELL PHONE: (956) 3880948

ashiellc@hotmail.com ashimportexport@gmail.com www.ashmex.com

# PRESSED POINT SEGURITY PICKETS

## LANZA "APACHE" CURVA

CODE	NAME	Ga	FINISH
ASH-0757	30° 3 MTS [ ] 1"	18	RED
ASH-0758	45° 3 MTS [ ] 1"	18	RED
ASH-0759	90° 3 MTS [ ] 1"	18	RED

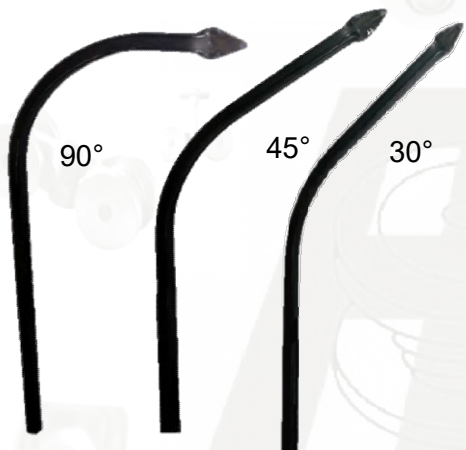

# LANZA APACHE

CODE	NAME	FINISH
ASH-0698	6" (15.24 CM) [ ] 1"	RED
ASH-0699	8" (20.32 CM) [ ] 1"	RED
ASH-0692	3.5 FT (1.066 M) [ ] 1"	RED
ASH-0695	6 FT (1.828 M) [ ] 1"	RED
ASH-0697	8 FT (2.438 M) [ ] 1"	RED

CODE	NAME	FINISH
ASH-0683	6" (15.24 CM) [ ] 3/4"	RED
ASH-0684	8" (20.32 CM) [ ] 3/4"	RED
ASH-0689	3.5 FT (1.06 M) [ ] 3/4"	RED
ASH-0680	6 FT (1.80 M) [ ] 3/4"	RED
ASH-0682	8 FT (2.40 M) [ ] 3/4"	RED

CODE	NAME	FINISH
ASH-0710	6" (15.24 CM) [ ] 1/2"	RED
ASH-0711	8" (20.32 CM) [ ] 1/2"	RED
ASH-0712	3.5 FT (1.06 M) [ ] 1/2"	RED
ASH-0713	6 FT (1.80 M) [ ] 1/2"	RED
ASH-0714	8 FT (2.40 M) [ ] 1/2"	RED



ABASTECEDORA DE SOLDADURA Y HERRAJES S.A. DE C.V.  
MIER Y NORIEGA No. 304 NTE. C.P. 67100 CD. GUADALUPE, N.L. MEXICO  
Conmutador: (81) 83-54-83-45 Fax: (81) 83-54-83-45  
admonventas@ashmex.com www.ashmex.com

ASH IMPORT & EXPORT LLC  
601-E CEDAR AVE, SUITE E MC ALLEN, TX 78501 USA  
PHONE/FAX : (956) 8004448 CELL PHONE: (956) 3880948  
ashiellc@hotmail.com ashimportexport@gmail.com www.ashmex.com



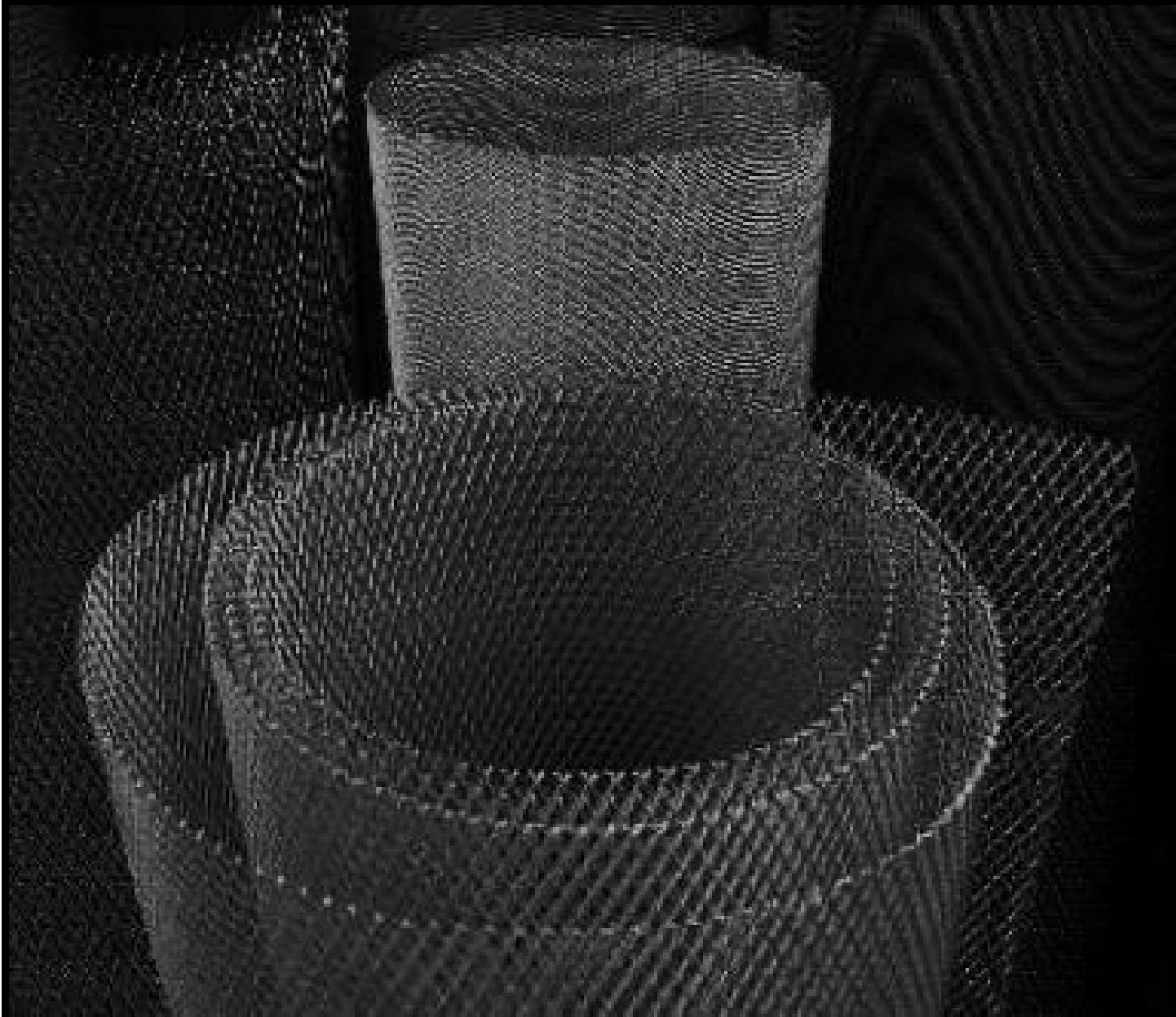

# ASH IMPORT & EXPORT LLC

601-E CEDAR AVE, SUITE E MC ALLEN, TX 78501 USA

PHONE/FAX: (956) 8004448 CELL PHONE: (956) 3880948

[ashiellc@hotmail.com](mailto:ashiellc@hotmail.com) [ashimportexport@gmail.com](mailto:ashimportexport@gmail.com) [www.ashmex.com](http://www.ashmex.com)