

## Abastecedora de Soldadura y Herrajes

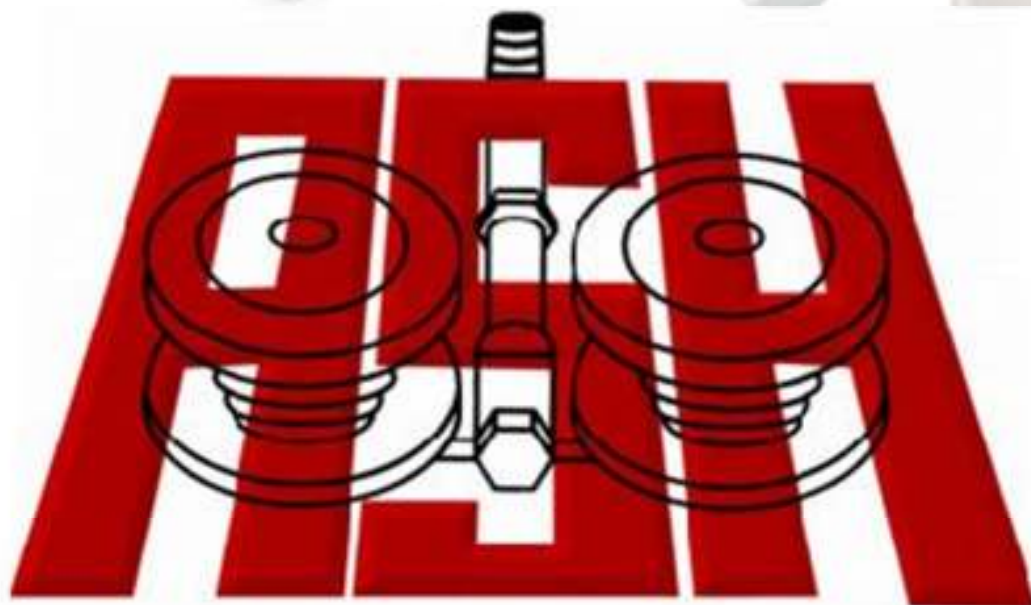

# Fabricación De Herrajes.



## ABASTECEDORA DE SOLDADURA Y HERRAJES S.A. DE C.V.

FABRICANTES DE HERRAJES, METAL DESPLEGADO, TORNILLERIA,  
EXPANSORES Y FUNDICION DE FIERRO VACIADO, ALUMINIO Y BRONCE

MIER Y NORIEGA No. 304 NTE. C.P. 67100 CD.GUADALUPE, N.L. MEXICO

TELS: 8354-8345, 8354-8346, 8354-8348 Y 8354-8359 FAX: 8354-8385

[ashmexsa@yahoo.com](mailto:ashmexsa@yahoo.com) [www.ashmex.com](http://www.ashmex.com)



**I  
N  
S  
T  
A  
L  
A  
C  
I  
O  
N  
E  
S**

**EQUIPO ASH**



**SALA DE EXHIBICION Y VENTAS**

**PLANTA  
MAS DE 8000 m2  
PRODUCIENDO PARA  
USTED**



**INGENIERIA Y  
MANTENIMIENTO  
PROPIOS**



**AREAS DE  
METAL  
DESPLIEGADO**



**AMPLIOS ALMACENES  
QUE OFRECEN GRAN  
SURTIDO**

**ATENCION A  
OBREROS  
Y EMPLEADOS**



**AREA DE  
GALVANIZADO  
ECOLOGICO NO  
CONTAMINANTE**



**AREAS DE  
TORNOS AUTOMATICOS**



**1 DE LAS 3 AREAS  
DE TROQUELADO**



## TAQUETE EXPANSOR



| CODIGO   | DESCRIPCION                        | PESO     | DIAMETRO | LARGO  |
|----------|------------------------------------|----------|----------|--------|
| ASH-0520 | "TX" CON TORNILLO ( 6.35MM.) 1/4"  | 0.030 Kg | 1/4"     | 2 1/2" |
| ASH-0521 | "TX" CON TORNILLO ( 7.93MM.) 5/16" | 0.040 Kg | 5/16"    | 2 1/2" |
| ASH-0522 | "TX" CON TORNILLO ( 9.52MM.) 3/8"  | 0.060 Kg | 3/8"     | 3"     |
| ASH-0531 | "TX" CON TORNILLO (12.7MM.) 1/2"   | 0.120 Kg | 1/2"     | 3 1/4" |
| ASH-0532 | "TX" CON TORNILLO (15.87MM.) 5/8"  | 0.210 Kg | 5/8"     | 4 "    |
| ASH-0533 | "TX" CON TORNILLO (19.05MM.) 3/4"  | 0.380 Kg | 3/4"     | 5 1/2" |

## PLACA BASE SOLDABLE

| CODIGO   | DESCRIPCION           | LARGO | ANCHO | PESO     | TORNILLO |
|----------|-----------------------|-------|-------|----------|----------|
| ASH-0605 | 4 Ø de 5/16" 2" X 2"  | 2"    | 2"    | .090 KG  | 3/16"    |
| ASH-0606 | 4 Ø de 3/8" 3" X 3"   | 3"    | 3"    | .200 KG  | 3/16"    |
| ASH-0607 | 4 Ø de 3/8" 4" X 4"   | 4"    | 4"    | .370 KG  | 3/16"    |
| ASH-0907 | 4 Ø de 1/2" 5" X 5"   | 5"    | 5"    | .770 KG  | 1/4"     |
| ASH-0608 | 4 Ø de 7/16" 6" X 6"  | 6"    | 6"    | 1.110 KG | 1/4"     |
| ASH-0609 | 4 Ø de 1/2" 8" X 8"   | 8"    | 8"    | 1.990 KG | 1/4"     |
| ASH-0701 | 4 Ø de 5/8" 10" X 10" | 10"   | 10"   | 4.880 KG | 3/8"     |
| ASH-0702 | 4 Ø de 3/4" 12" X 12" | 12"   | 12"   | 9.140 KG | 1/2"     |



## PERICO PARA VENTANA



| CODIGO    | DESCRIPCION                     |
|-----------|---------------------------------|
| ASH-0075  | A.S.H. (ACERO)                  |
| ASH-0076  | CON DOBLEZ PARA VENTANA (ACERO) |
| ASH-0079* | ZAMAK                           |

## JALADERAS

| CODIGO   | DESCRIPCION                                 | LARGO  | ANCHO  |
|----------|---|--------|--------|
| ASH-0154 | JALADERA TROQUELADA 2 AGUJEROS(GALVANIZADA) | 4 3/4" | 3 1/4" |
| ASH-0155 | JALADERA TROQUELADA 4 AGUJEROS(GALVANIZADA) | 6"     | 1 3/8" |



## MANIJA GALVANIZADA



| CODIGO    | DESCRIPCION                      | CAL. |
|-----------|----------------------------------|------|
| ASH-0224  | MANIJA TUBULAR CLASICA DERECHA   | 20   |
| ASH-0225  | MANIJA TUBULAR CLASICA IZQUIERDA | 20   |
| ASH-0222* | MANIJA PLANA DERECHA AZUL        | 12   |
| ASH-0223* | MANIJA PLANA IZQUIERDA AZUL      | 12   |

## RESORTE GALVANIZADO

| CODIGO    | DESCRIPCION                          | LARGO   |
|-----------|--------------------------------------|---------|
| ASHD-0277 | RESORTE PARA PUERTA MOSQUITERA GALV. | 16 1/4" |



| CODIGO   | DESCRIPCION                       |
|----------|-----------------------------------|
| ASH-0042 | BISAGRA DE PROYECCION C-10 CAL 10 |

## PORTACHAPAS

| CODIGO   | DESCRIPCION                            | DIAMETRO | LARGO  | ANCHO  | CALIBRE |
|----------|--|----------|--------|--------|---------|
| ASH-0509 | PORTA CHAPA EMBUTIDO DOBLE 1" NEGRO    | 2 1/8"   | 7"     | 5 1/2" | 1"      |
| ASH-0510 | PORTA CHAPA EMBUTIDO SENCILLO 1" NEGRO | 2 1/8"   | 4 1/4" | 3 1/2" | 1"      |



| CODIGO   | DESCRIPCION                            | DIAMETRO | LARGO  | ANCHO  | CALIBRE |
|----------|--|----------|--------|--------|---------|
| ASH-0611 | PORTA CHAPA LISO DOBLE 1 1/4" NEGRO    | 2 1/8"   | 6 3/4" | 5 1/2" | 1 1/4"  |
| ASH-0612 | PORTA CHAPA LISO SENCILLO 1 1/4" NEGRO | 2 1/8"   | 5 1/2" | 3 1/2" | 1 1/4"  |

## RODILLOS

| CODIGO   | DESCRIPCION   | DIAMETRO | LARGO |
|----------|---|----------|-------|
| ASH-0610 | RODILLO DE HULE LATERAL PARA PORTON 3" GALV. C/PERNOS | 2.5"     | 3"    |
| ASH-0724 | RODILLO DE HULE LATERAL PARA PORTON 6" GALV. C/PERNOS | 2.5"     | 6"    |
| ASH-0886 | RODILLO GUIA DE HULE ECONOMICO 3" NEGRO               | 2.5"     | 3"    |
| ASH-0887 | RODILLO GUIA DE HULE ECONOMICO 6" NEGRO               | 2.5"     | 6"    |



## CLIP PARA POLIN



| CODIGO   | DESCRIPCION                             | U.V. | LARGO | ANCHO  |
|----------|---|------|-------|--------|
| ASH-0156 | CLIP PARA POLIN 4" (0.44 KG) (0.750 LB) | KG   | 4"    | 2 1/4" |
| ASH-0159 | CLIP PARA POLIN 5" (0.53 KG) (1.17 LB)  | KG   | 5"    | 2 1/4" |
| ASH-0160 | CLIP PARA POLIN 6" (0.61 KG) (1.30 LB)  | KG   | 6"    | 2 1/4" |
| ASH-0162 | CLIP PARA POLIN 8" (0.56 KG) (1.50 LB)  | KG   | 8"    | 2 1/4" |
| ASH-0163 | CLIP PARA POLIN 10" (0.92 KG) (2.10 LB) | KG   | 10"   | 2 1/4" |

## ESFERA TROQUELADA

| CODIGO   | DESCRIPCION                                       | DIAMETRO |
|----------|---|----------|
| ASH-0450 | ESFERA TROQUELADA (25MM.) 1" ENTRADA SENCILLA     | 1"       |
| ASH-0451 | ESFERA TROQUELADA (38MM.) 1 1/2" DOBLE ENTRADA    | 1 1/2"   |
| ASH-0452 | ESFERA TROQUELADA (38MM.) 1 1/2" ENTRADA SENCILLA | 1 1/2"   |
| ASH-0453 | ESFERA TROQUELADA (51MM.) 2" DOBLE ENTRADA        | 2"       |
| ASH-0454 | ESFERA TROQUELADA (51MM.) 2" ENTRADA SENCILLA     | 2"       |



## BISAGRA DE LIBRO CIEGA



| CODIGO   | DESCRIPCION                           |
|----------|---------------------------------------|
| ASH-0009 | BALERO 350 VENTANA RADIAL GALVANIZADO |

| CODIGO   | DESCRIPCION              | LARGO | ANCHO  |
|----------|--------------------------|-------|--------|
| ASH-0673 | 2X2 GRUESA CAL. 14       | 2"    | 2"     |
| ASH-0690 | 2 1/4 X 3 1/2 CAL. 14    | 3.5"  | 2 1/4" |
| ASH-0674 | 3X3 GRUESA CAL. 13       | 3"    | 3"     |
| ASH-0675 | 3.5 X 3.5 GRUESA CAL. 13 | 3.5"  | 3.5"   |
| ASH-0676 | 4X4 GRUESA CAL. 12       | 4"    | 4"     |

## MECANISMO GALVANIZADO

| CODIGO   | DESCRIPCION                             | PESO     |
|----------|---|----------|
| ASH-0282 | MECANISMO GALVANIZADO 4" (102 X 128MM.) | .790 KG  |
| ASH-0280 | MECANISMO GALVANIZADO 6" (145 X 162MM.) | 1.080 KG |



ABASTECEDORA DE SOLDADURA Y HERRAJES S.A. DE C.V.  
 MIER Y NORIEGA No. 304 NTE. C.P. 67100 CD. GUADALUPE, N.L. MEXICO  
 Conmutador: (81) 83-54-83-45 Fax: (81) 83-54-83-45  
 admonventas@ashmex.com www.ashmex.com

ASH IMPORT & EXPORT LLC  
 601-E CEDAR AVE, SUITE E MC ALLEN, TX 78501 USA  
 PHONE/FAX : (956) 8004448 CELL PHONE: (956) 3880948  
 ashiellc@hotmail.com ashimportexport@gmail.com www.ashmex.com

# MORDAZA PARA PTR



| CODIGO   | DESCRIPCION                                |
|----------|--|
| ASH-0660 | MORDAZA PARA PTR EN ACERO GALV. 3/8 X 1/4" |
| ASH-0661 | MORDAZA PARA PTR EN ACERO GALV. 3/8 X 3/8" |



# TROLES ASH

## TROLE TIPO JALON ASH COLOR VERDE.

| CODIGO    | DESCRIPCION  |
|-----------|--|
| ASH-0548X | TROLE TIPO JALON ASH 250KG. RUEDA REFORZADA (VERDE)  |
| ASH-0549X | TROLE TIPO JALON ASH 500KG. RUEDA REFORZADA (VERDE)  |
| ASH-0550X | TROLE TIPO JALON ASH 1000KG. RUEDA REFORZADA (VERDE) |

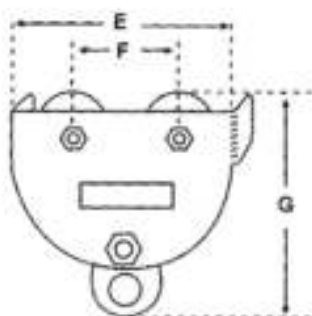
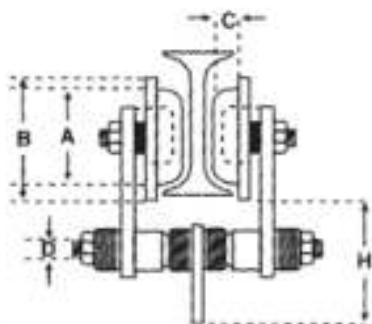

| Modelo | CAP. TONS. | PESO LBS. KGS. | PERALTE VIGA | ANCHO PATIN | RADIO GIRO | A      | B      | C      | D     | E       | F      | G       | H      | MEDIDA EN |
|--------|------------|----------------|--------------|-------------|------------|--------|--------|--------|-------|---------|--------|---------|--------|-----------|
| P-250  | 25         | 5              | 3" - 9"      | 1.8" - 4"   | 36"        | 1.900" | 2.675" | 63"    | .750" | 8.110"  | 3.750" | 4.75"   | 4.5"   | PULG.     |
|        |            |                | 76 - 228     | 45 - 101    | 914        | 48.20  | 69     | 18     | 19    | 208     | 95     | 120     | 114    | MM.       |
| P-500  | 500        | 8              | 3" - 15"     | 2.5" - 5.3" | 36"        | 2.175" | 3.050" | .825"  | .875" | 8.620"  | 5.150" | 5.150"  | 6.250" | PULG.     |
|        |            |                | 76 - 381     | 63 - 135    | 900        | 55.24  | 77     | 20.95  | 22    | 219     | 130    | 130     | 155    | MM.       |
| P-1000 | 1          | 12             | 5" - 24"     | 3" - 5"     | 40"        | 3.175" | 4"     | 1.250" | 1.0"  | 11.330" | 5.980" | 11.250" | 7.260" | PULG.     |
|        |            |                | 127 - 609    | 76 - 203    | 124        | 80.64  | 101    | 31.75  | 25.4  | 288     | 152    | 285     | 185    | MM.       |

- Las placas laterales son de acero.
- Las ruedas son de fundición gris maquinadas.
- Cada rueda lleva un balero sellado.
- Chumacera soldadas de tubo mecánico para mayor estabilidad.
- El eje principal lleva rondanas de ajuste para diferentes anchos de patín.
- Oreja de acero para insertar el gancho del polipasto.
- Las placas son dobladas en cada extremo y sirven como guardas para protección del trole.
- Estos troles se usan en vigas IPS ó IPR.

Hecho en México

ABASTECEDORA DE SOLDADURA Y HERRAJES S.A. DE C.V.  
 MIER Y NORIEGA No. 304 NTE. C.P. 67100 CD. GUADALUPE, N.L. MEXICO  
 Conmutador: (81) 83-54-83-45 Fax: (81) 83-54-83-45  
 admonventas@ashmex.com www.ashmex.com

ASH IMPORT & EXPORT LLC  
 601-E CEDAR AVE, SUITE E MC ALLEN, TX 78501 USA  
 PHONE/FAX : (956) 8004448 CELL PHONE: (956) 3880948  
 ashiellc@hotmail.com ashimportexport@gmail.com www.ashmex.com

# TROLES ASH

## TROLE ECONOMICO ASH COLOR AZUL.

| CODIGO   | DESCRIPCION  |
|----------|--|
| ASH-0901 | TROLE ECONOMICO ASH 250KG. RUEDA MAQUINADA (AZUL)  |
| ASH-0902 | TROLE ECONOMICO ASH 500KG. RUEDA MAQUINADA (AZUL)  |
| ASH-0903 | TROLE ECONOMICO ASH 1000KG. RUEDA MAQUINADA (AZUL) |

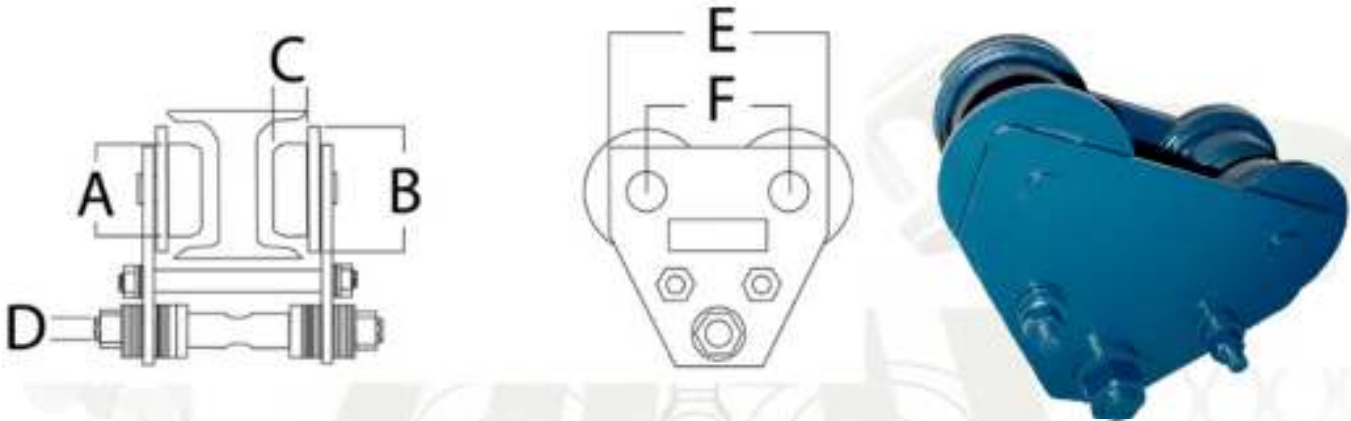

| MODELO      | CAP.  | PESO KGS. | ANCHO PATIN     | PERALTE VIGA | A      | B      | C      | D      | E      | F       |
|-------------|-------|-----------|-----------------|--------------|--------|--------|--------|--------|--------|---------|
| ECOMET 250  | ¼ TON | 4         | 2.2" - 3"       | 3" - 8"      | 2.185" | 3.062" | 0.820" | 0.750" | 7.250" | 4.1875" |
| ECOMET 500  | ½ TON | 4.3       | 2.2" - 3"       | 3" - 8"      | 2.185" | 3.062" | 0.820" | 0.750" | 7.250" | 4.1875" |
| ECOMET 1000 | 1 TON | 8         | 2.875" - 4.025" | 4" - 9"      | 3.180" | 4"     | 1.145" | 0.875" | 10"    | 6.125"  |

- Placas laterales de acero
- Ruedas de fundición gris maquinadas
- Un balero sellado en cada rueda
- Un eje principal, más dos refuerzos de acero con rondanas de ajuste.
- Útil tanto en viga IPS como IPR

Hecho en México



# CORREDERAS DE 4 RUEDAS PARA RIEL 1500

| CODIGO    | DESCRIPCION  | DIAMETRO | LARGO  | ANCHO  | CAPACIDAD X |
|-----------|--|----------|--------|--------|-------------|
|           |  |          |        |        | PAR         |
| ASH-0668* | 9001 RUEDAS Y CUERPO TROQUELADOS EN LAM. CAL. 14                 | 2"       | 4 3/4" | 1 1/2" | 150 KG      |
| ASH-0669* | 9051 RUEDA MAQUINADA CON BALERO Y CUERPO TROQ. EN LAM. CAL. 14   | 2"       | 5"     | 1 1/2" | 180 KG      |
| ASH-0099* | 9100 RUEDA MAQUINADA SOLIDA Y CUERPO DE SOLERA 1 1/4" x 3/4"     | 2"       | 5"     | 1 1/2" | 150 KG      |
| ASH-0210  | 9120 "4 RUEDAS" CUERPO CUAD. 3/4" RUEDA TROQUELADA               | 2"       |        | 1 1/2" |             |
| ASH-0412* | 9140 RUEDA MAQUINADA CON BALERO Y CUERPO CUADRADO DE 3/4"        | 2"       | 4 3/4" | 1 1/2" | 200 KG      |
| ASH-0100* | 9150 RUEDA MAQUINADA CON BALERO Y CUERPO DE SOLERA 1 1/4" x 3/4" | 2"       | 5"     | 1 1/2" | 200 KG      |



9001

Corredera 9001  
Ruedas & Cuerpo  
Troquelados en  
Lamina Cal. 14



9051

Corredera 9051  
Cuerpo Troquelado  
Rueda Maquinada  
C/Balero & Perno  
de 3/4 "



9120

Corredera 9120 "4  
Ruedas" Cuerpo  
Cuadrado 3/4 "  
Rueda Troquelada



9140

Corredera 9140  
Cuerpo Cuadrado  
de 3/4"  
Rueda Maq.  
C/Balero & Perno  
de 3/4 "



9100

Corredera 9100  
Cuerpo en Solera  
de 1 1/4" x 3/4"  
Rueda Maq. Solida  
c/ Perno de 1/2"  
& Buje de Bronce.



Corredera 9150  
Cuerpo en Solera  
de 1 1/4 " x 3/4 "  
Rueda Maq.  
C/Balero & Perno  
de 3/4 "



# CORREDERA PARA RIEL 1500 DE 4 RUEDAS MODELO 9001

Carrucha 9001 Completamente Mejorada



- \* *Su cuerpo es Troquelado Laminado en Cal. 14".*
- \* *Cuerpo Engargolado*
- \* *Buje de acero maquinado, pernos en acero de alta resistencia*
- \* *Acabado Tropicalizado.*
- \* *Mayor Resistencia a la corrosión.*
- \* *Ruedas Troqueladas Lam. Cal 14"*
- \* *Con función de sujeta tornillo para una mejor instalación.*

[www.ashmex.com](http://www.ashmex.com)



# **CORREDERA PARA RIEL 1500 DE 4 RUEDAS MODELO 9051**

**Carrucha 9051 Completamente Mejorada**



- \* *Su Cuerpo es Troquelado Laminado en Cal. 14".*
- \* *Cuerpo Engargolado*
- \* *Acabado Tropicalizado.*
- \* *Mayor Resistencia a la corrosion.*
- \* *Eje de mayor diámetro lo que permite una mayor capacidad de carga*
- \* *Ruedas Maquinadas C/Balero & Perno de 3/4 "*
- \* *Con función de sujeta tornillo para una mejor instalación.*



# **CORREDERA PARA RIEL 1500 DE 4 RUEDAS MODELO 9120**

**Carrucha 9120 Cuerpo Cuadrado 3/4 "**



**\*Cuerpo cuadrado de 3/4 "**

**\*Ruedas Troqueladas en Lamina Cal. 14**

**\*Buje de acero maquinado, pernos en acero de alta resistencia.**

**\* Acabado Tropicalizado.**

**\* Mayor Resistencia a la corrosion.**

**\*Con función de sujeta tornillo para una mejor instalación.**

[www.ashmex.com](http://www.ashmex.com)



# CORREDERA PARA RIEL 1500 DE 4 RUEDAS MODELO 9140

Carrucha 9140 Cuerpo Cuadrado de  $\frac{3}{4}$ "



\*Cuerpo Cuadrado de  $\frac{3}{4}$ "

\*Ruedas Maquinadas C/Balero &

\*Perno de  $\frac{3}{4}$  " de alta resistencia.

\* Acabado Tropicalizado.

\* Mayor Resistencia a la corrosion.

*\*Con función de sujeta tornillo para una mejor instalación.*

[www.ashmex.com](http://www.ashmex.com)



# CORREDERA PARA RIEL 1500 DE 4 RUEDAS MODELO 9100

Carrucha 9100 Cuerpo Solera 1 1/4" x 3/4"



PRODUCTO  
**NUEVO**

\*Cuerpo en Solera de 1 1/4" x 3/4"

\*Ruedas Maquinadas Solidas  
c/ Perno de 1/2"  
& Buje de Bronce.

\* *Acabado Tropicalizado.*

\* *Mayor Resistencia a la corrosion.*

\* *Con función de sujeta tornillo para una mejor instalación.*

[www.ashmex.com](http://www.ashmex.com)

ABASTECEDORA DE SOLDADURA Y HERRAJES S.A. DE C.V.  
MIER Y NORIEGA No. 304 NTE. C.P. 67100 CD. GUADALUPE, N.L. MEXICO  
Conmutador: (81) 83-54-83-45 Fax: (81) 83-54-83-45  
admonventas@ashmex.com www.ashmex.com

ASH IMPORT & EXPORT LLC  
601-E CEDAR AVE, SUITE E MC ALLEN, TX 78501 USA  
PHONE/FAX : (956) 8004448 CELL PHONE: (956) 3880948  
ashiellc@hotmail.com ashimportexport@gmail.com www.ashmex.com



## CORREDERA PARA RIEL 1500 DE 4 RUEDAS MODELO 9150

Carrucha 9150 Cuerpo en Solera 1 1/4" x 3/4"



\*Cuerpo en Solera de 1 1/4 " x 3/4 "

\*Ruedas Maquinadas solidas

\*C/Balero & Perno de 3/4 "

\* *Acabado Tropicalizado.*

\* *Mayor Resistencia a la corrosion.*

\* *Con función de sujeta tornillo para una mejor instalación.*

[www.ashmex.com](http://www.ashmex.com)

ABASTECEDORA DE SOLDADURA Y HERRAJES S.A. DE C.V.  
MIER Y NORIEGA No. 304 NTE. C.P. 67100 CD. GUADALUPE, N.L. MEXICO  
Conmutador: (81) 83-54-83-45 Fax: (81) 83-54-83-45  
admonventas@ashmex.com www.ashmex.com

ASH IMPORT & EXPORT LLC  
601-E CEDAR AVE, SUITE E MC ALLEN, TX 78501 USA  
PHONE/FAX : (956) 8004448 CELL PHONE: (956) 3880948  
ashiellc@hotmail.com ashimportexport@gmail.com www.ashmex.com

# CORREDERAS DE 4 RUEDAS PARA RIEL 1400

| CODIGO    | DESCRIPCION   | DIAMETR |        |        | CAPACIDAD X PAR |
|-----------|---|---------|--------|--------|-----------------|
|           |   | O       | LARGO  | ANCHO  |                 |
| ASH-0095* | 8001 RUEDAS Y CUERPO TROQ. EN LAM. CAL. 14 «ECONOMICA»                  | 1"      | 2 1/2" | 1 1/2" | 60 KG           |
| ASH-0197* | 8051 RUEDAS SOLIDAS DE 1" C/BALEROS & CUERPO TROQUELADO                 | 1"      | 2 1/2" | 1 1/2" | 75 KG           |
| ASH-0150* | 8151 RUEDAS SOLIDAS DE 1" C/BALEROS & CUERPO REFORZADO CUADRADO DE 5/8" | 1"      | 3"     | 1 1/2" | 100 KG          |



8001

Corredera 8001  
Cuerpo & Ruedas  
Troqueladas en  
Lam. Cal. 14



8051

Corredera 8051  
Cuerpo Troquelado  
Ruedas de 1"  
C/Balero.



8151

Corredera 8151  
Cuerpo Ref.  
Cuadrado de 5/8"  
Ruedas de 1"  
C/Balero.

Maq. =Maquinada  
Troq. =Troquelada  
Lam. = Lamina





# CORREDERA PARA RIEL 1400 DE 4 RUEDAS MODELO 8001

Carrucha 8001



- \* *Su cuerpo es Troquelado Laminado en Cal. 14".*
- \* *Acabado Tropicalizado.*
- \* *Mayor Resistencia a la corrosion.*
- \* *Rueda Troquelada y Remachada.*
- \* *Con función de sujeta tornillo para una mejor instalación.*



[www.ashmex.com](http://www.ashmex.com)



# CORREDERA PARA RIEL 1400 DE 4 RUEDAS MODELO 8051

Carrucha 8051



*\* Su cuerpo es Troquelado Laminado en Cal. 14".*

*\* Acabado Tropicalizado.*

*\* Mayor Resistencia a la corrosion.*

*\* Función de un rodamiento tipo automotriz ya que esta elaborada*

*\* con posta de 1/8 entre las ruedas y el eje reforzado*

*\* Rueda con guía*

*maquinada en acero de 1"*

*\* Con función de sujeta tornillo para una mejor instalacion.*



[www.ashmex.com](http://www.ashmex.com)



# CORREDERA PARA RIEL 1400 DE 4 RUEDAS MODELO 8151

Carrucha 8151



- \*Cuerpo solido y cuadrado 5/8
- \*Acabado Tropicalizado.
- \* Mayor Resistencia a la corrosion.
- \* Con función de sujeta tornillo para una mejor instalaci3n.
- \* Ruedas con postas para mejor deslizamiento y mayor carga



[www.ashmex.com](http://www.ashmex.com)

## RUEDAS MAQUINADAS PARA ANGULO 90°

| CODIGO                 | DESCRIPCION                               | DIAMETRO | ANCHO  | CAPACIDAD X PAR |
|------------------------|---|----------|--------|-----------------|
| <b>RUEDA CON CAJA</b>  |   |          |        |                 |
| ASH-0516               | 2" X 5/8" C/ BALERO REFORZADA.            | 2"       | 5/8"   | 100 KG.         |
| ASH-0530               | 2-1/2" X 3/4" C/ BALERO REFORZADA.        | 2 1/2"   | 3/4"   | 150 KG.         |
| ASH-0517               | 3" X 3/4" C/ BALERO REFORZADA.            | 3"       | 3/4"   | 200 KG.         |
| ASH-0620               | 3" X 1 1/2" C/ BALERO REF. TRABAJO PESADO | 3"       | 1 1/2" | 400 KG.         |
| ASH-0892               | 4" X 1 3/4" C/BALERO REFORZADA.           | 4"       | 1 3/4" |                 |
| <b>RUEDAS SIN CAJA</b> |   |          |        |                 |
| ASH-0428               | 2" X 5/8" CON BALERO REFORZADA            | 2"       | 5/8"   | 100 KG.         |
| ASH-0543               | 2-1/2" X 3/4" CON BALERO REFORZADA        | 2 1/2"   | 3/4"   | 150 KG.         |
| ASH-0495               | 3" X 3/4" CON BALERO REFORZADA.           | 3"       | 3/4"   | 200 KG.         |
| ASH-0625               | 3" X 1 1/2" C/BALERO REF. TRABAJO PESADO  | 3"       | 1 1/2" | 400 KG.         |
| ASH-0891               | 4" X 1 3/4" C/BALERO REFORZADA.           | 4"       | 1 3/4" |                 |



## RUEDAS MAQUINADAS EN RADIO PARA REDONDOS

| CODIGO                 | DESCRIPCION               | DIAMETRO | ANCHO  | CAPACIDAD X PAR |
|------------------------|---------------------------|----------|--------|-----------------|
| <b>RUEDA CON CAJA</b>  |                           |          |        |                 |
| ASH-0715               | 2"X 5/8" C/BAL.REF.TROP.  | 2"       | 5/8"   | 100 KG.         |
| ASH-0717               | 2-1/2"X3/4" C/BAL.REF.    | 2 1/2"   | 3/4"   | 150 KG.         |
| ASH-0716               | 3"X 3/4"C/BAL.REF.        | 3"       | 3/4"   | 200 KG.         |
| ASH-0718               | 3"X1 1/2" TRABAJO PESADP  | 3"       | 1 1/2" | 400 KG.         |
| <b>RUEDAS SIN CAJA</b> |                           |          |        |                 |
| ASH-0720               | 2"X 5/8" C/BALERO REF.    | 2"       | 5/8"   | 100 KG.         |
| ASH-0722               | 2-1/2"X3/4" C/BALERO REF. | 2 1/2"   | 3/4"   | 150 KG.         |
| ASH-0721               | 3"X 3/4"C/BALERO REF.     | 3"       | 3/4"   | 200 KG.         |
| ASH-0719               | 3"X1 1/2" TRABAJO PESADO  | 3"       | 1 1/2" | 400 KG.         |



## RUEDAS DE FIERRO VACIADO

| CODIGO                | DESCRIPCION                | DIAMETRO | GROSOR | CAPACIDAD |
|-----------------------|----------------------------|----------|--------|-----------|
| <b>RUEDA SIN CAJA</b> |                            |          |        |           |
| ASH-0502              | 4" DOBLE BALERO            | 4"       | 1 3/4" | 150 lb.   |
| ASH-0503              | 4" "CON CAJA" DOBLE BALERO | 4"       | 1 3/4" | 150 lb.   |
| ASH-0504              | 6" DOBLE BALERO            | 6"       | 2 1/2" | 200 lb.   |
| ASH-0505              | 6" "CON CAJA" DOBLE BALERO | 6"       | 2 1/2" | 200 lb.   |



ABASTECEDORA DE SOLDADURA Y HERRAJES S.A. DE C.V.  
 MIER Y NORIEGA No. 304 NTE. C.P. 67100 CD. GUADALUPE, N.L. MEXICO  
 Conmutador: (81) 83-54-83-45 Fax: (81) 83-54-83-45  
 admonventas@ashmex.com www.ashmex.com

ASH IMPORT & EXPORT LLC  
 601-E CEDAR AVE, SUITE E MC ALLEN, TX 78501 USA  
 PHONE/FAX : (956) 8004448 CELL PHONE: (956) 3880948  
 ashiecll@hotmail.com ashimportexport@gmail.com www.ashmex.com



## RUEDAS MAQUINADAS PARA ANGULO 90° & EN RADIO PARA REDONDOS.

*\*Rueda de acero maquinado en acero 1018 perno exacto con las medida exacta del balero evitando uso de bujes acabado tropicalizado. Caja troquelada de una sola pieza evitando el uso múltiple de soldaduras en Cal. 12*

### MEDIDAS:

2 X 3/4" : carga por par 100 kg

2 1/2 X 3/4" : carga por par 150 kg

3" X 3/4" : carga por par 200 kg

3" X 1 1/2" (Trabajo Pesado) : carga por par 400 kg



## RUEDAS DE FIERRO VACIADO

*\*Reforzada con doble balero automotriz, perno con la medida exacta del interior de los baleros permitiendo con esto mayor ajuste y evitando el uso de bujes. Caja troquelada de una sola pieza evitando el uso múltiple de soldaduras*

### MEDIDAS:

Rueda de 4" : carga por par 500 kg

Rueda de 6" : carga por par 600 kg



## ARO DE PERFIL TUBULAR CUAD. 1/2" CAL 16

| CODIGO    | DESCRIPCION | DIAMETRO | LARGO  | ANCHO  |
|-----------|-------------|----------|--------|--------|
| ASFC-0620 | ARO 4 "     | 4"       | 4"     | 4"     |
| ASFC-0621 | ARO 4 1/2"  | 4 1/2"   | 4 1/2" | 4 1/2" |
| ASFC-0622 | ARO 5"      | 5"       | 5"     | 5"     |



## BIBEL PIVOTE



| CODIGO   | DESCRIPCION  |
|----------|--|
| ASH-0565 | BIBEL PIVOTE 1/2" (6" X 1 1/2" X 3/16") ACABADO NATURAL  |
| ASH-0768 | BIBEL PIVOTE 1/2" (6" X 1" X 1/4") ACABADO NATURAL       |
| ASH-0770 | BIBEL PIVOTE 1/2" (7" X 1" X 1/4") ACABADO NATURAL       |
| ASH-0507 | BIBEL PIVOTE 3/4" (8" X 2 1/2" X 1/4") GRANDE CON BALERO |
| ASH-0508 | BIBEL PIVOTE 5/8" (6" X 1 1/2" X 1/4") CHICO CON BALERO  |
| ASH-0769 | BIBEL PIVOTE 5/8" (6" X 1 1/2" X 3/16") ACABADO NATURAL  |
| ASH-0767 | BIBEL PIVOTE 5/8" (7" X 1 1/2" X 1/4") ACABADO NATURAL   |
| ASH-0771 | BIBEL PIVOTE 5/8" (7" X 1 1/4" X 1/4") ACABADO NATURAL   |
| ASH-0566 | BIBEL PIVOTE 5/8" (6" X 2" X 1/4") GRANDE SIN BALERO     |
| ASH-0506 | BIBEL PIVOTE 5/8" (7" X 2" X 1/4") MEDIANO CON BALERO    |
| ASH-0164 | BIBEL PIVOTE 5/8" (7" X 2" X 1/4") ASH INFERIOR          |
| ASH-0165 | BIBEL PIVOTE 5/8" (7" X 2" X 1/4") ASH SUPERIOR          |

## RIEL EN ANGULO ESPECIAL PARA RUEDAS DE 2", 2 1/2", 3", 4" Y 6"

- \* En acero galvanizado Cal. 10
- \* Fabricada en una sola pieza.
- \* Largo de 10 FT
- \* Con agujeros de 1/4"



| CODIGO   | DESCRIPCION         | LARGO | PESO    |
|----------|---------------------|-------|---------|
| ASH-0704 | RIEL GUIA EN ANGULO | 10 FT | 6.00 KG |

## ANILLO PARA LANZA PTR DECORATIVA



| CODIGO   | DESCRIPCION          |
|----------|----------------------|
| ASH-0733 | ANILLO PARA PTR 1/2" |

## MECANISMO PARA PUERTA CORREDIZA



| CODIGO   | DESCRIPCION                      | LARGO   | ANCHO  |
|----------|----------------------------------|---------|--------|
| ASH-0667 | MECANISMO SIN RUEDA              | 12 1/2" | 3 3/4" |
| ASH-0707 | MECANISMO CON RUEDA GIRATORIA 3" | 17"     | 3 3/4" |

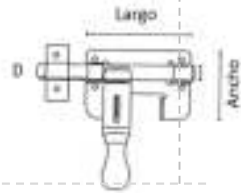

# PASADORES

## PASADOR OREJON No. 3



| CODIGO   | DESCRIPCION                      | ACABADO | CAL. LAMINA |
|----------|----------------------------------|---------|-------------|
| ASH-0708 | PASADOR OREJON No. 3 REF. Ø 1/2" | NATURAL | 12          |

## PASADOR AMBIDIESTRO RUSTICO



| CODIGO    | DESCRIPCION                            | ACABADO | CAL.   |      |       |       |
|-----------|--|---------|--------|------|-------|-------|
|           |  |         | LAMINA | D    | LARGO | ANCHO |
| ASH-0240  | RUSTICO No.4 REF. Ø 5/8" R10           | Negro   | 11     | 5/8" | 4"    | 3"    |
| ASH-0241  | RUSTICO No.5 REF. Ø 5/8" R15           | Negro   | 11     | 5/8" | 5"    | 3"    |
| ASH-0242  | RUSTICO No.6 REF. Ø 5/8" R25           | Negro   | 11     | 5/8" | 6"    | 3"    |
| ASH-0202X | RUSTICO NEG. No.5X EXTRA REF. Ø 3/4" C | Negro   | 11     | 3/4" |       |       |
| ASH-0203X | RUSTICO NEG. No.6X EXTRA REF. Ø 3/4" C | Negro   | 11     | 3/4" |       |       |

## PASADOR AMBIDIESTRO CLASICO

| CODIGO   | DESCRIPCION                | ACABADO     | CAL.   |      |        |        |          | PESO |
|----------|----------------------------|-------------|--------|------|--------|--------|----------|------|
|          |                            |             | LAMINA | D    | LARGO  | ANCHO  |          |      |
| ASH-0257 | CLASICO No.3 PESADO Ø 3/8" | Galvanizado | 14     | 3/8" | 3 1/2" | 4 1/4" | 0.150 KG |      |
| ASH-0258 | CLASICO No.4 PESADO Ø 1/2" | Galvanizado | 12     | 1/2" | 4"     | 4 3/4" | 0.260 KG |      |
| ASH-0259 | CLASICO No.5 PESADO Ø 5/8" | Galvanizado | 12     | 5/8" | 5"     | 5 1/4" | 0.480 KG |      |
| ASH-0260 | CLASICO No.6 PESADO Ø 5/8" | Galvanizado | 12     | 5/8" | 6"     | 5 3/4" | 0.551 KG |      |
| ASH-0651 | CLASICO No.7 PESADO Ø 3/4" | Galvanizado | 11     | 3/4" | 11"    | 6"     |          |      |



## PASADOR AMBIDIESTRO CLASICO ECONOMICO

| CODIGO    | DESCRIPCION                   | ACABADO     | CAL.   |        |
|-----------|-------------------------------|-------------|--------|--------|
|           |                               |             | LAMINA | LARGO  |
| ASHD-0379 | CLASICO No.3 ECONOMICO Ø 3/8" | Galvanizado | 18     | 3 1/2" |
| ASHD-0377 | CLASICO No.4 ECONOMICO Ø 1/2" | Galvanizado | 18     | 4"     |
| ASHD-0378 | CLASICO No.5 ECONOMICO Ø 5/8" | Galvanizado | 18     | 5"     |

## PASADOR AMBIDIESTRO COLONIAL



| CODIGO   | DESCRIPCION                 | ACABADO     | CAL.   |      |        |        |  |
|----------|-----------------------------|-------------|--------|------|--------|--------|--|
|          |                             |             | LAMINA | D    | LARGO  | ANCHO  |  |
| ASH-0523 | COLONIAL No.4 REF. Ø 5/8"   | Negro       | 11     | 5/8" | 6"     | 5"     |  |
| ASH-0524 | COLONIAL No.6 REF. Ø 3/4"   | Negro       | 11     | 3/4" | 8 1/2" | 5"     |  |
| ASH-0525 | COLONIAL No.7 REF. Ø 3/4"   | Negro       | 11     | 3/4" | 10"    | 5 1/2" |  |
| ASH-0569 | COLONIAL No.9 Extra REF Ø1" | Negro       | 11     | 1"   | 13"    | 8"     |  |
| ASH-0526 | COLONIAL No.4 REF. Ø 5/8"   | Galvanizado | 11     | 5/8" | 6"     | 5"     |  |
| ASH-0527 | COLONIAL No.6 REF. Ø 3/4"   | Galvanizado | 11     | 3/4" | 8 1/2" | 5"     |  |
| ASH-0528 | COLONIAL No.7 REF. Ø 3/4"   | Galvanizado | 11     | 1"   | 13"    | 8"     |  |

ABASTECEDORA DE SOLDADURA Y HERRAJES S.A. DE C.V.

MIER Y NORIEGA No. 304 NTE. C.P. 67100 CD. GUADALUPE, N.L. MEXICO

Conmutador: (81) 83-54-83-45 Fax: (81) 83-54-83-45

admonventas@ashmex.com www.ashmex.com

ASH IMPORT & EXPORT LLC

601-E CEDAR AVE, SUITE E MC ALLEN, TX 78501 USA

PHONE/FAX : (956) 8004448 CELL PHONE: (956) 3880948

ashiellc@hotmail.com ashimportexport@gmail.com www.ashmex.com

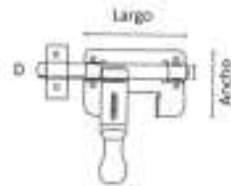

## **PASADOR No. 3**



***PASADOR No. 3 «OREJON»***

***\*Barra en redondo de ½"***

***\*Cuerpo mas grueso en calibre 12***

***\*Troquelado en una sola pieza***

***\*Menos soldadura = Una mejor presentación***

[www.ashmex.com](http://www.ashmex.com)

ABASTECEDORA DE SOLDADURA Y HERRAJES S.A. DE C.V.  
MIER Y NORIEGA No. 304 NTE. C.P. 67100 CD. GUADALUPE, N.L. MEXICO  
Conmutador: (81) 83-54-83-45 Fax: (81) 83-54-83-45  
admonventas@ashmex.com www.ashmex.com

ASH IMPORT & EXPORT LLC  
601-E CEDAR AVE, SUITE E MC ALLEN, TX 78501 USA  
PHONE/FAX : (956) 8004448 CELL PHONE: (956) 3880948  
ashiellc@hotmail.com ashimportexport@gmail.com www.ashmex.com



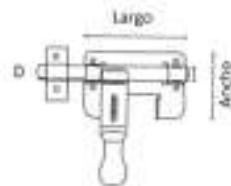
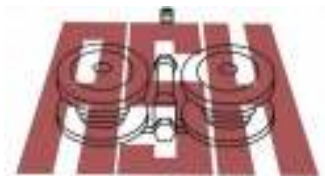

## PASADOR AMB. RUSTICO



***Medidas 4" 5" & 6"***

***\*Barra en redondo de 5/8"***

***\*Cuerpo mas grueso en calibre 11***

***\*Troquelado en una sola pieza***

***\*Menos soldadura = Una mejor  
presentación***

***Medidas 5x" & 6x"***

***\*Barra en redondo de 3/4"***

***\*Cuerpo mas grueso en calibre 11***

***\*Troquelado en una sola pieza***

***\*Menos soldadura = Una mejor  
presentación***

[www.ashmex.com](http://www.ashmex.com)

ABASTECEDORA DE SOLDADURA Y HERRAJES S.A. DE C.V.  
MIER Y NORIEGA No. 304 NTE. C.P. 67100 CD. GUADALUPE, N.L. MEXICO  
Conmutador: (81) 83-54-83-45 Fax: (81) 83-54-83-45  
admonventas@ashmex.com www.ashmex.com

ASH IMPORT & EXPORT LLC  
601-E CEDAR AVE, SUITE E MC ALLEN, TX 78501 USA  
PHONE/FAX : (956) 8004448 CELL PHONE: (956) 3880948  
ashiellc@hotmail.com ashimportexport@gmail.com www.ashmex.com

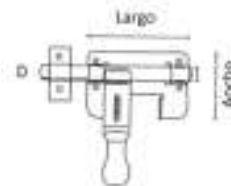
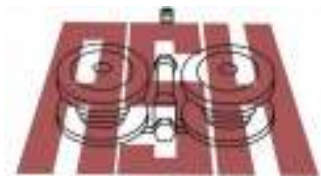

## **PASADOR AMB. GALVANIZADO**

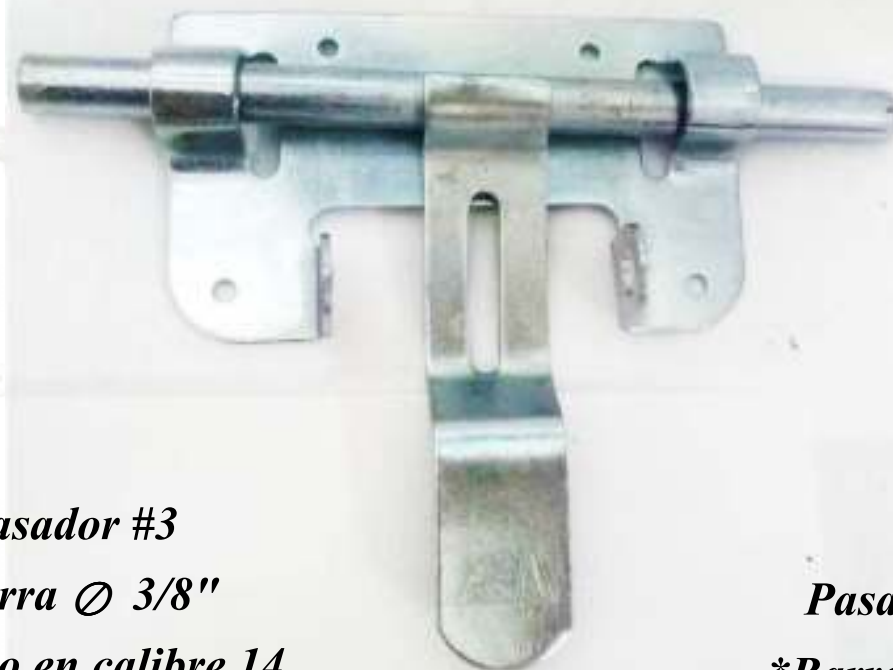

***Pasador #3***

***\*Barra Ø 3/8"***

***\*Cuerpo en calibre 14***

***Pasador #4***

***\*Barra Ø 1/2"***

***\*Cuerpo en calibre 12***

***Pasador #5***

***\*Barra Ø 5/8"***

***\*Cuerpo en calibre 12***

***Pasador #6***

***\*Barra Ø 5/8"***

***\*Cuerpo en calibre 12***

***Pasador #7***

***\*Barra Ø 3/4"***

***\*Cuerpo en calibre 11***

***\*Troquelado en una sola pieza***

***\*Menos soldadura = Una mejor***

***presentación***

**[www.ashmex.com](http://www.ashmex.com)**

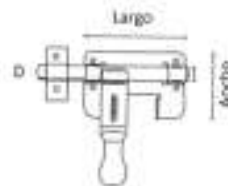
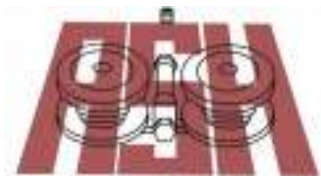

## PASADOR AMB. COLONIAL NEGRO



*Pasador #4*

*\*Barra Ø 5/8"*

*\*Cuerpo en calibre 11*

*Pasador #7*

*\*Barra Ø 3/4"*

*\*Cuerpo en calibre 11*

*Pasador #6*

*\*Barra Ø 3/4"*

*\*Cuerpo en calibre 11*

*Pasador #9*

*\*Barra Ø 1"*

*\*Cuerpo en calibre 11*

*\*Troquelado en una sola pieza*

*\*Menos soldadura = Una mejor presentación*

[www.ashmex.com](http://www.ashmex.com)

ABASTECEDORA DE SOLDADURA Y HERRAJES S.A. DE C.V.  
MIER Y NORIEGA No. 304 NTE. C.P. 67100 CD. GUADALUPE, N.L. MEXICO  
Conmutador: (81) 83-54-83-45 Fax: (81) 83-54-83-45  
admonventas@ashmex.com www.ashmex.com

ASH IMPORT & EXPORT LLC  
601-E CEDAR AVE, SUITE E MC ALLEN, TX 78501 USA  
PHONE/FAX : (956) 8004448 CELL PHONE: (956) 3880948  
ashiellc@hotmail.com ashimportexport@gmail.com www.ashmex.com

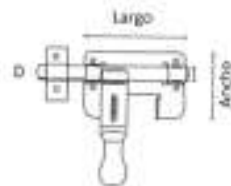
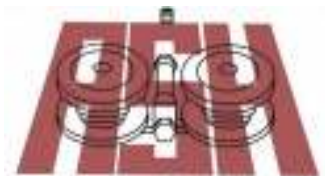

# PASADOR AMB. COLONIAL GALVANIZADO



*Pasador #4*

*\*Barra  $\varnothing$  5/8"*

*\*Cuerpo en calibre 11*

*Pasador #6*

*\*Barra  $\varnothing$  3/4"*

*\*Cuerpo en calibre 11*

*Pasador #7*

*\*Barra  $\varnothing$  3/4"*

*\*Cuerpo en calibre 11*

*\*Troquelado en una sola pieza*

*\*Menos soldadura = Una mejor presentación*

[www.ashmex.com](http://www.ashmex.com)

ABASTECEDORA DE SOLDADURA Y HERRAJES S.A. DE C.V.  
MIER Y NORIEGA No. 304 NTE. C.P. 67100 CD. GUADALUPE, N.L. MEXICO  
Conmutador: (81) 83-54-83-45 Fax: (81) 83-54-83-45  
admonventas@ashmex.com www.ashmex.com

ASH IMPORT & EXPORT LLC  
601-E CEDAR AVE, SUITE E MC ALLEN, TX 78501 USA  
PHONE/FAX : (956) 8004448 CELL PHONE: (956) 3880948  
ashiellc@hotmail.com ashimportexport@gmail.com www.ashmex.com

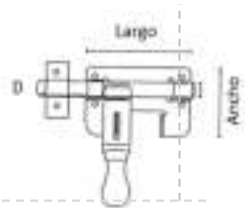

# PASADORES

## PASADOR AMBIDIESTRO GIGANTE DE TUBO

| CODIGO   | DESCRIPCION                      | ACABADO | CAL. LAMINA | LARGO   |
|----------|----------------------------------|---------|-------------|---------|
| ASH-0232 | PASADOR NATURAL CAL. 11 CED.40   | NATURAL | 13          | 14 1/2" |
| ASH-0212 | PASADOR GALV. 15R 1 5/16" CED 40 | GALV    | 10          | 15"     |



## PASADOR PORTACANDADO



| CODIGO   | DESCRIPCION        | ACABADO     | CAL. LAMINA | LARGO  | ANCHO  |
|----------|--------------------|-------------|-------------|--------|--------|
| ASH-0254 | PORTACANDADO No. 2 | Galvanizado | 14          | 2 3/4" | 1 1/2" |
| ASH-0255 | PORTACANDADO No. 4 | Galvanizado | 14          | 4"     | 2"     |
| ASH-0256 | PORTACANDADO No. 6 | Galvanizado | 14          | 6"     | 2"     |

## PASADOR CERROJO

| CODIGO   | DESCRIPCION            | ACABADO | CAL. LAMINA | LARGO   | ANCHO   | PESO     |
|----------|------------------------|---------|-------------|---------|---------|----------|
| ASH-0244 | CERROJO (80-30) 1 1/4" | Galv.   | 18          | 1 1/4 " | 1 1/4 " | 0.035 KG |
| ASH-0243 | CERROJO (80-40) 1 1/2" | Galv.   | 18          | 1 1/2"  | 1 1/2 " | 0.050 KG |
| ASH-0245 | CERROJO (80-50) 2 "    | Galv.   | 18          | 2 "     | 2 "     | 0.070 KG |
| ASH-0246 | CERROJO (80-60) 2 1/2" | Galv.   | 18          | 2 1/2"  | 2 1/2"  | 0.070 KG |
| ASH-0247 | CERROJO (80-75) 3"     | Galv.   | 18          | 3 "     | 3 "     | 0.080 KG |
| ASH-0248 | CERROJO (80-102) 4"    | Galv.   | 18          | 4 "     | 4 "     |          |



## PASADOR CERROJO ECONOMICO

| CODIGO    | DESCRIPCION                    | ACABADO       | ANCHO  |
|-----------|--------------------------------|---------------|--------|
| ASHD-0384 | CERROJO ECO. No. (80-30) 1 1/4 | Tropicalizado | 1 1/4" |
| ASHD-0385 | CERROJO ECO No. (80-50) 2"     | Tropicalizado | 2"     |
| ASHD-0388 | CERROJO ECO No. (80-60) 2 1/2" | Tropicalizado | 2 1/2" |
| ASHD-0386 | CERROJO ECO No. (80-75) 3"     | Tropicalizado | 3"     |
| ASHD-0387 | CERROJO ECO No. (80-102) 4"    | Tropicalizado | 4"     |



## PASADOR DE SEGURIDAD



| CODIGO    | DESCRIPCION                | ACABADO       | CAL. LAMINA | LARGO   | ANCHO  | PESO     |
|-----------|----------------------------|---------------|-------------|---------|--------|----------|
| ASH-0262  | PASADOR DE SEGURIDAD No. 2 | Tropicalizado | 16          | 2"      | 1 1/2" | 0.050 KG |
| ASH-0263X | PASADOR DE SEGURIDAD No. 4 | Tropicalizado | 16          | 3 1/2 " | 1 1/2" | 0.080 KG |

## PASADOR MULTIUSOS

| CODIGO   | DESCRIPCION              | ACABADO       | CAL. LAMINA | LARGO | ANCHO | PESO     |
|----------|--------------------------|---------------|-------------|-------|-------|----------|
| ASH-0173 | MULTIUSOS No. 4 CUAD.1/2 | Tropicalizado | 13          | 6"    | 2"    | 0.330 KG |
| ASH-0187 | MULTIUSOS No. 5 CUAD.5/8 | Tropicalizado | 13          | 8"    | 2"    | 0.610 KG |



ABASTECEDORA DE SOLDADURA Y HERRAJES S.A. DE C.V.  
 MIER Y NORIEGA No. 304 NTE. C.P. 67100 CD. GUADALUPE, N.L. MEXICO  
 Conmutador: (81) 83-54-83-45 Fax: (81) 83-54-83-45  
 admonventas@ashmex.com www.ashmex.com

ASH IMPORT & EXPORT LLC  
 601-E CEDAR AVE, SUITE E MC ALLEN, TX 78501 USA  
 PHONE/FAX : (956) 8004448 CELL PHONE: (956) 3880948  
 ashiellc@hotmail.com ashimportexport@gmail.com www.ashmex.com

# PASADORES DE PISO

## PASADOR DE PISO CUADRADO

| CODIGO    | DESCRIPCION               | ACABADO     | CAL. LAMINA |
|-----------|---------------------------|-------------|-------------|
| ASH-0234* | CUADRADO No. 9 (A20) 1/2" | Galvanizado | 12          |
| ASH-0236* | CUADRADO No.12 (A30) 1/2" | Galvanizado | 12          |
| ASH-0238* | CUADRADO No.16 (A40) 1/2" | Galvanizado | 12          |
| ASH-0479* | CUADRADO No.18 (A50) 1/2" | Galvanizado | 12          |
| ASH-0239* | CUADRADO No.22 (A60) 1/2" | Galvanizado | 12          |

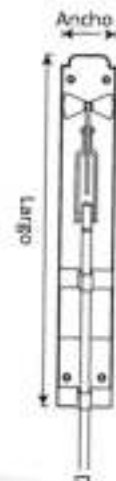

## PASADOR DE PISO REDONDO

| CODIGO    | DESCRIPCION                     | ACABADO     | CAL. LAMINA |
|-----------|---------------------------------|-------------|-------------|
| ASH-0341* | REDONDO No. 9 (A20) $\phi$ 1/2" | Galvanizado | 12          |
| ASH-0342* | REDONDO No.12 (A30) $\phi$ 5/8" | Galvanizado | 12          |
| ASH-0343* | REDONDO No.16 (A40) $\phi$ 5/8" | Galvanizado | 12          |
| ASH-0344* | REDONDO No.22 (A60) $\phi$ 5/8" | Galvanizado | 12          |



## PASADOR DE PISO RUSTICO



| CODIGO   | DESCRIPCION          | ACABADO | CAL.   |      |       |        |
|----------|----------------------|---------|--------|------|-------|--------|
|          |                      |         | LAMINA | D    | LARGO | ANCHO  |
| ASH-0250 | RUSTICO No. 9 (A20)  | Negro   | 10     | 5/8" | 9"    | 1 1/4" |
| ASH-0251 | RUSTICO No. 12 (A30) | Negro   | 10     | 5/8" | 12"   | 1 1/4" |
| ASH-0252 | RUSTICO No. 16 (A40) | Negro   | 10     | 5/8" | 16"   | 1 1/4" |
| ASH-0480 | RUSTICO No. 18 (A50) | Negro   | 10     | 5/8" | 18"   | 1 1/4" |
| ASH-0253 | RUSTICO No. 22 (A60) | Negro   | 10     | 5/8" | 22"   | 1 1/4" |

## PASADOR DE PISO RUSTICO ECONOMICO

| CODIGO   | DESCRIPCION       | ACABADO | CAL.   |        |       |        |
|----------|-------------------|---------|--------|--------|-------|--------|
|          |                   |         | LAMINA | $\phi$ | LARGO | ANCHO  |
| ASH-0905 | RUSTICO NEG. No9  | Negro   | 12     | 1/2"   | 9"    | 1 1/4" |
| ASH-0906 | RUSTICO NEG. No12 | Negro   | 12     |        | 12    | 1 1/4" |
| ASH-0908 | RUSTICO NEG. No16 | Negro   | 12     | 1/2"   | 16"   | 1 1/4" |



## PASADOR DE PISO DE BOLA



| CODIGO   | DESCRIPCION       | ACABADO | CAL. BARR |                |       |        |
|----------|-------------------|---------|-----------|----------------|-------|--------|
|          |                   |         | LAMINA    | A              | LARGO | ANCHO  |
| ASH-0166 | BOLA DOBLE No. 9  | Negro   | 10        | $\square$ 1/2" | 9"    | 2 3/4" |
| ASH-0167 | BOLA DOBLE No. 12 | Negro   | 10        | $\square$ 1/2" | 12"   | 0 3/4" |
| ASH-0168 | BOLA DOBLE No. 16 | Negro   | 10        | $\square$ 1/2" | 16"   | 1 3/4" |
| ASH-0169 | BOLA DOBLE No. 22 | Negro   | 10        | $\square$ 1/2" | 22"   | 1 3/4" |

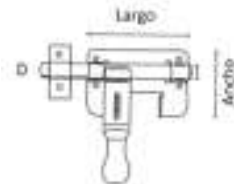
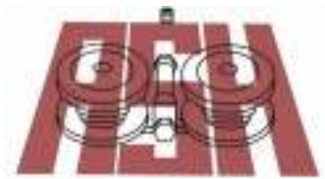

## **PASADOR DE PISO GALVANIZADO** **CUADRADO & REDONDO**



*Cuadrado Medidas*

*9" 12" 16" 18" & 22"*

*\*Barra en cuadrado de 1/2"*

*\*Cuerpo mas grueso en calibre 12*

*\*Troquelado en una sola pieza*

*\*Menos soldadura = Una mejor presentación*

[www.ashmex.com](http://www.ashmex.com)

ABASTECEDORA DE SOLDADURA Y HERRAJES S.A. DE C.V.  
MIER Y NORIEGA No. 304 NTE. C.P. 67100 CD. GUADALUPE, N.L. MEXICO  
Conmutador: (81) 83-54-83-45 Fax: (81) 83-54-83-45  
admonventas@ashmex.com www.ashmex.com

ASH IMPORT & EXPORT LLC  
601-E CEDAR AVE, SUITE E MC ALLEN, TX 78501 USA  
PHONE/FAX : (956) 8004448 CELL PHONE: (956) 3880948  
ashiellc@hotmail.com ashimportexport@gmail.com www.ashmex.com

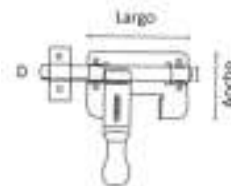
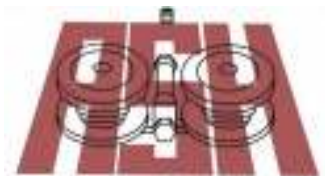

## PASADOR DE PISO NEGRO RUSTICO



*Rustico Medidas*

*9" 12" 16" 18" & 22"*

*\*Barra en redondo de 5/8"*

*\*Cuerpo mas grueso en calibre 10*

*\*Menos soldadura = Una mejor presentación*

[www.ashmex.com](http://www.ashmex.com)

ABASTECEDORA DE SOLDADURA Y HERRAJES S.A. DE C.V.  
MIER Y NORIEGA No. 304 NTE. C.P. 67100 CD. GUADALUPE, N.L. MEXICO  
Conmutador: (81) 83-54-83-45 Fax: (81) 83-54-83-45  
admonventas@ashmex.com www.ashmex.com

ASH IMPORT & EXPORT LLC  
601-E CEDAR AVE, SUITE E MC ALLEN, TX 78501 USA  
PHONE/FAX : (956) 8004448 CELL PHONE: (956) 3880948  
ashiellc@hotmail.com ashimportexport@gmail.com www.ashmex.com



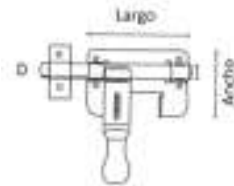
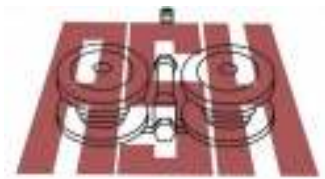

## PASADOR DE PISO NEGRO DE BOLA



*De Bola Medidas*

*9" 12" 16" & 22"*

*\*Barra en cuadrado de 1/2"*

*\*Cuerpo mas grueso en calibre 10*

*\*Menos soldadura = Una mejor presentación*

[www.ashmex.com](http://www.ashmex.com)

ABASTECEDORA DE SOLDADURA Y HERRAJES S.A. DE C.V.  
MIER Y NORIEGA No. 304 NTE. C.P. 67100 CD. GUADALUPE, N.L. MEXICO  
Conmutador: (81) 83-54-83-45 Fax: (81) 83-54-83-45  
admonventas@ashmex.com www.ashmex.com

ASH IMPORT & EXPORT LLC  
601-E CEDAR AVE, SUITE E MC ALLEN, TX 78501 USA  
PHONE/FAX : (956) 8004448 CELL PHONE: (956) 3880948  
ashiellc@hotmail.com ashimportexport@gmail.com www.ashmex.com

# CHAPETONES & CANASTAS

| CODIGO    | DESCRIPCION                  | LARGO  | ANCHO  | PESO     |
|-----------|------------------------------|--------|--------|----------|
| ASHT-0125 | ALA DE ANGEL DERECHA NEGRO   | 4 3/8" | 1 5/8" | 0.209 KG |
| ASHT-0126 | ALA DE ANGEL IZQUIERDA NEGRO | 4 3/8" | 1 5/8" | 0.209 KG |



## PIÑAS / CANASTAS



| CODIGO     | DESCRIPCION   | LARGO  | GROSOR |
|------------|---|--------|--------|
| ASHT-0017X | CANASTA B-515 (1 1/2" Ø 5" ALTO) [ ] 1/2"           | 5"     | 1 1/2" |
| ASHT-0039X | CANASTA B-520 (1 3/4" Ø 5" ALTO) [ ] 1/2"           | 5"     | 1 3/4" |
| ASHT-0014  | CANASTA B-521 (2 1/4" Ø 5 1/4" ALTO) (710) [ ] 1/2" | 5 1/4" | 2 1/4" |
| ASHT-0051  | CANASTA B-522 (2 1/4" Ø 5 1/2" ALTO) (709) [ ] 1/2" | 5 1/2" | 2 1/4" |

## CHAPETONES CAL. 14

| CODIGO    | NOMBRE  | ACABADO |
|-----------|---|---------|
| ASHT-0148 | CHICO "FLOR" L-211CRN (NEGRO) CON REMACHE           | NATURAL |
| ASHT-0136 | CHICO "FLOR" L-212CRN (NEGRO) CON REMACHE           | NATURAL |
| ASHT-0138 | CHICO "FLOR" L-212SRG (GALVANIZADO) SIN REMACHE     | NATURAL |
| ASHT-0093 | CHICO "FLOR" L-411CRT (TROPICALIZADO) CON REMACHE   | NATURAL |
| ASHT-0151 | CHICO (FLOR) L-211 S/REM. 3/8" Ø INT. 2 1/4" Ø EXT. | NATURAL |
| ASHT-0139 | CHICO (FLOR) L-212 S/REM. 3/8" Ø INT. 2 1/4" Ø EXT. | NATURAL |
| ASHT-0142 | CHICO (FLOR)L-210 C/REM. 3/8" Ø INT. 2 1/4" Ø EXT.  | NATURAL |
| ASHT-0145 | CHICO (FLOR)L-210 S/REM. 3/8" Ø INT. 2 1/4" Ø EXT.  | NATURAL |
| ASHT-0189 | ESTRELLA L-100REG (GALVANIZADO) CON REMACHE         | NATURAL |
| ASHT-0190 | ESTRELLA L-100REN (NEGRO) CON REMACHE               | NATURAL |
| ASHT-0091 | GRANDE "FLOR" L-411CRN (NEGRO) CON REMACHE NEGRO    | NATURAL |
| ASHT-0119 | GRANDE (FLOR) L-410 C/REM. 3/8" Ø INT. 3 1/2" Ø EXT | NATURAL |
| ASHT-0120 | GRANDE (FLOR) L-410 S/REM. 3/8" Ø INT. 3 1/2" Ø EXT | NATURAL |
| ASHT-0122 | GRANDE (FLOR) L-410 S/REM. 3/8" Ø INT. 3 1/2" Ø EXT | NATURAL |
| ASHT-0121 | GRANDE (FLOR) L-410 S/REM.3/8" Ø INT. 3 1/2" Ø EXT. | NATURAL |
| ASHT-0090 | (FLOR) L-411 C/REM.3/8" Ø INT. 3 3/4" Ø EXT.        | NATURAL |
| ASHT-0089 | GRANDE (FLOR) L-411 S/REM. 3/8" Ø INT. 3 3/4" Ø EXT | NATURAL |
| ASHT-0022 | GRANDE (FLOR) L-411SRN S/REM.3/8" Ø INT. 3 3/4" Ø E | NATURAL |
| ASHT-0133 | GRANDE (FLOR) L-412 S/REM. 3/8" Ø INT. 3 1/2" Ø EXT | NATURAL |
| ASHT-0130 | GRANDE (FLOR)L-412CRN C/REM. 3/8" Ø INT. 3 1/2" Ø E | NATURAL |
| ASHT-0157 | "FLORES" L-610CRN (NEGRO) CON REMACHE               | NATURAL |
| ASHT-0160 | "FLORES" L-611CRN (NEGRO) CON REMACHE               | NATURAL |
| ASHT-0154 | "FLORES" L-612CRN (NEGRO) CON REMACHE               | NATURAL |



ASHT-0148



ASHT-0145



ASHT-0136



ASHT-0151



ASHT-0157



ASHT-0154



ASHT-0160

ASHT-0190



ASHT-0090



ASHT-0089



ABASTECEDORA DE SOLDADURA Y HERRAJES S.A. DE C.V.  
 MIER Y NORIEGA No. 304 NTE. C.P. 67100 CD. GUADALUPE, N.L. MEXICO  
 Conmutador: (81) 83-54-83-45 Fax: (81) 83-54-83-45  
 admonventas@ashmex.com www.ashmex.com

ASH IMPORT & EXPORT LLC  
 601-E CEDAR AVE, SUITE E MC ALLEN, TX 78501 USA  
 PHONE/FAX : (956) 8004448 CELL PHONE: (956) 3880948  
 ashiellc@hotmail.com ashimportexport@gmail.com www.ashmex.com

# BISAGRAS TUBULARES & ESPECIALES

## BISAGRA RECTANGULAR NEGRA MAQUINADA C/ GRASERA

| CODIGO   | DESCRIPCION                            |
|----------|--|
| ASH-0888 | BISAGRA RECTANGULAR 4" X 1" X 1/2"     |
| ASH-0889 | BISAGRA RECTANGULAR 5" X 1 1/2" X 3/4" |
| ASH-0890 | BISAGRA RECTANGULAR 6" X 2" X 1"       |



## BISAGRA TUBULAR DOBLE C/GRASERA



| CODIGO   | DESCRIPCION              | DIAMETRO |
|----------|--------------------------|----------|
| ASH-0574 | 3/4" CON 2 GRAS 2 HEM    | 3/4"     |
| ASH-0573 | 1" CON 2 GRAS 2 HEM.     | 1"       |
| ASH-0575 | 1 1/4" CON 2 GRAS 2 HEM. | 1 1/4"   |
| ASH-0576 | 1 1/2" CON 2 GRAS 2 HEM. | 1 1/2"   |

## BISAGRA TUBULAR CON PLACA Y GRASERA

| CODIGO   | DESCRIPCION                    | DIAMETRO | LARGO | ANCHO | PESO     |
|----------|--------------------------------|----------|-------|-------|----------|
| ASH-0546 | BISAGRA PLACA (25.4MM.) 1"     | 1"       | 5"    | 1"    | 0.572 KG |
| ASH-0671 | BISAGRA PLACA (32.0 MM) 1 1/4" | 1 1/4"   | 6"    | 3/8"  | 1.091 KG |
| ASH-0547 | BISAGRA PLACA (38.1MM.) 1 1/2" | 1 1/2"   | 7"    | 3/8"  | 1.396 KG |
| ASH-0672 | BISAGRA PLACA (50.8 MM) 2"     | 2"       | 8"    | 3/8"  | 3.000 KG |



## BISAGRA TUBULAR NEGRA MAQUINADA



| CODIGO   | DESCRIPCION            | DIAMETRO | LARGO  |
|----------|------------------------|----------|--------|
| ASH-0147 | BISAGRA (15.9MM.) 5/8" | 5/8"     | 2 3/8" |
| ASH-0058 | BISAGRA (19.0MM.) 3/4" | 3/4"     | 2 3/4" |
| ASH-0059 | BISAGRA (25.4MM.) 1"   | 1"       | 3 1/2" |

## BISAGRA TUBULAR FORJADA

| CODIGO   | DESCRIPCION       | DIAMETRO | LARGO  |
|----------|-------------------|----------|--------|
| ASH-0067 | BIS. TUBULAR 3/8" | 3/8"     | 2 3/8" |
| ASH-0068 | BIS. TUBULAR 1/2" | 1/2"     | 2 3/8" |
| ASH-0069 | BIS. TUBULAR 5/8" | 5/8"     | 2 3/8" |



## BISAGRA TUBULAR MAQUINADA C/GRASERA

## BISAGRA TEJUELO

| CODIGO   | DESCRIPCION    | DIAMETRO | LARGO  |
|----------|----------------|----------|--------|
| ASH-0174 | TEJUELO 1"     | 1"       | 1 1/4" |
| ASH-0175 | TEJUELO 1 1/4" | 1 1/4"   | 1 1/2" |
| ASH-0176 | TEJUELO 1 1/2" | 1 1/2"   | 1 1/2" |
| ASH-0177 | TEJUELO 2"     | 2"       | 1 1/2" |
| ASH-0432 | TEJUELO 2 1/2" | 2 1/2"   | 1 3/4" |
| ASH-0433 | TEJUELO 3"     | 3"       | 2 1/2" |

| CODIGO   | DESCRIPCION    | DIAMETRO | LARGO  |
|----------|----------------|----------|--------|
| ASH-0426 | BISAGRA 5/8"   | 5/8"     | 3 3/8" |
| ASH-0427 | BISAGRA 3/4"   | 3/4"     | 3 3/4" |
| ASH-0060 | BISAGRA 1"     | 1"       | 4"     |
| ASH-0061 | BISAGRA 1 1/4" | 1 1/4"   | 4 1/2" |
| ASH-0062 | BISAGRA 1 1/2" | 1 1/2"   | 4 3/4" |
| ASH-0063 | BISAGRA 2"     | 2"       | 6"     |



## BISAGRA ANCLA



| CODIGO   | DESCRIPCION  | LARGO  | ANCHO  |
|----------|--------------|--------|--------|
| ASH-0035 | ANCLA 3/4"   | 4"     | 4"     |
| ASH-0036 | ANCLA 1"     | 4"     | 4"     |
| ASH-0038 | ANCLA 1 1/4" | 4"     | 4"     |
| ASH-0037 | ANCLA 1 1/2" | 5 1/4" | 4 1/2" |
| ASH-0039 | ANCLA 2"     | 6"     | 5 1/4" |

ABASTECEDORA DE SOLDADURA Y HERRAJES S.A. DE C.V.

MIER Y NORIEGA No. 304 NTE. C.P. 67100 CD. GUADALUPE, N.L. MEXICO  
 Conmutador: (81) 83-54-83-45 Fax: (81) 83-54-83-45  
 admonventas@ashmex.com www.ashmex.com

ASH IMPORT & EXPORT LLC

601-E CEDAR AVE, SUITE E MC ALLEN, TX 78501 USA  
 PHONE/FAX : (956) 8004448 CELL PHONE: (956) 3880948  
 ashie LLC@hotmail.com ashimportexport@gmail.com www.ashmex.com

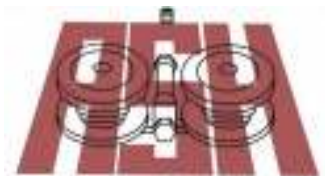

## BISAGRA DE ANCLA



### Medidas

*3/4" , 1" , 1 1/4" , 1 1/2" , 2"*

*\*Solera 3/16"*

*\*Fabricada en acero al carbón*

*\*Con Ancla para obtener mejor fijación en el cemento*

*Usos: Ideal para puertas y portones.*

[www.ashmex.com](http://www.ashmex.com)

ABASTECEDORA DE SOLDADURA Y HERRAJES S.A. DE C.V.  
MIER Y NORIEGA No. 304 NTE. C.P. 67100 CD. GUADALUPE, N.L. MEXICO  
Conmutador: (81) 83-54-83-45 Fax: (81) 83-54-83-45  
admonventas@ashmex.com www.ashmex.com

ASH IMPORT & EXPORT LLC  
601-E CEDAR AVE, SUITE E MC ALLEN, TX 78501 USA  
PHONE/FAX : (956) 8004448 CELL PHONE: (956) 3880948  
ashiellc@hotmail.com ashimportexport@gmail.com www.ashmex.com

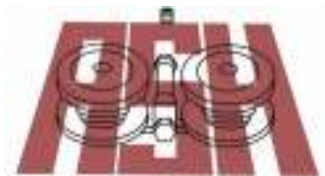

## TEJUELOS



### Medidas

*1", 1 1/4", 1 1/2", 2", 2 1/2", 3"*

*\*Usos: Ideal para puertas y portones.*

[www.ashmex.com](http://www.ashmex.com)

ABASTECEDORA DE SOLDADURA Y HERRAJES S.A. DE C.V.  
MIER Y NORIEGA No. 304 NTE. C.P. 67100 CD. GUADALUPE, N.L. MEXICO  
Conmutador: (81) 83-54-83-45 Fax: (81) 83-54-83-45  
admonventas@ashmex.com www.ashmex.com

ASH IMPORT & EXPORT LLC  
601-E CEDAR AVE, SUITE E MC ALLEN, TX 78501 USA  
PHONE/FAX : (956) 8004448 CELL PHONE: (956) 3880948  
ashiellc@hotmail.com ashimportexport@gmail.com www.ashmex.com



# NUEVOS PRODUCTOS



## BISAGRA TIPO BANDERA

| CODIGO   | DESCRIPCION                                     |
|----------|---|
| ASH-1000 | BISAGRA TIPO BANDERA CAL 11 PERNO SUELTO DE 1/2 |
| ASH-1006 | BISAGRA TIPO BANDERA CAL 11 PERNO SUELTO DE 3/8 |



## BISAGRA DOBLE TUBO CED. 40 CON PERNO SUELTO 3/4"



ABASTECEDORA DE SOLDADURA Y HERRAJES S.A. DE C.V.  
MIER Y NORIEGA No. 304 NTE. C.P. 67100 CD. GUADALUPE, N.L. MEXICO  
Conmutador: (81) 83-54-83-45 Fax: (81) 83-54-83-45  
admonventas@ashmex.com www.ashmex.com

ASH IMPORT & EXPORT LLC  
601-E CEDAR AVE, SUITE E MC ALLEN, TX 78501 USA  
PHONE/FAX : (956) 8004448 CELL PHONE: (956) 3880948  
ashiellc@hotmail.com ashimportexport@gmail.com www.ashmex.com

# TAPAS DECORATIVAS

## TAPA PARA PTR



| CODIGO   | DESCRIPCION                            |
|----------|--|
| ASH-0652 | TAPA PARA PTR 1/2" DECORATIVA CAL 18   |
| ASH-0655 | TAPA PARA PTR 3/4" DECORATIVA CAL 18   |
| ASH-0657 | TAPA PARA PTR 1/2" DECORATIVA CAL 18   |
| ASH-0653 | TAPA PARA PTR 1" DECORATIVA CAL. 18    |
| ASH-0656 | TAPA PARA PTR 1-1/4" DECORATIVA CAL 16 |
| ASH-0654 | TAPA PARA PTR 1-1/2" DECORATIVA CAL 16 |
| ASH-0646 | TAPA PARA PTR 2" DECORATIVA CAL 14     |
| ASH-0647 | TAPA PARA PTR 2-1/2" DECORATIVA CAL 14 |
| ASH-0648 | TAPA PARA PTR 3" DECORATIVA CAL.14     |
| ASH-0649 | TAPA PARA PTR 3-1/2" DECORATIVA CAL.12 |
| ASH-0650 | TAPA PARA PTR 4" DECORATIVA CAL.12     |

## TAPA PARA TUBO MECANICO

| CODIGO   | MEDIDAS                |
|----------|------------------------|
| ASH-0773 | MECANICO 1" CAL 12     |
| ASH-9999 | MECANICO 3/4" CAL 12   |
| ASH-0775 | MECANICO 1 1/4" CAL 12 |
| ASH-0774 | MECANICO 1 1/2" CAL 12 |
| ASH-0776 | MECANICO 2" CAL 12     |
| ASH-0777 | MECANICO 2 1/2" CAL 12 |
| ASH-0778 | MECANICO 3" CAL 12     |
| ASH-0780 | MECANICO 3 1/2" CAL 12 |
| ASH-0779 | MECANICO 4"            |

## TAPA PARA TUBO COMERCIAL

| CODIGO   | DESCRIPCION                              |
|----------|--|
| ASH-0734 | 3/4 COMERCIAL(1/2 ESFERA-BOTON)CAL 14    |
| ASH-0736 | 1" COMERCIAL(1/2 ESFERA-BOTON)CAL 14     |
| ASH-0737 | 1 1/4" COMERCIAL(1/2 ESFERA-BOTON)CAL 14 |
| ASH-0738 | 1 1/2 COMERCIAL(1/2 ESFERA-BOTON)CAL 14  |
| ASH-0739 | 2" COMERCIAL(1/2 ESFERA-BOTON)CAL 13     |
| ASH-0740 | 2 1/2 COMERCIAL(1/2 ESFERA-BOTON)CAL 12  |
| ASH-0741 | 3" COMERCIAL(1/2 ESFERA-BOTON)CAL 12     |
| ASH-0742 | 3 1/2" COMERCIAL(1/2 ESFERA-BOTON)CAL 12 |
| ASH-0743 | 4" COMERCIAL(1/2 ESFERA-BOTON)CAL 12     |



## PLATOS PORTA VELA



| CODIGO   | DESCRIPCION                             | U.V. | DIAMETRO |
|----------|---|------|----------|
| ASH-0130 | CURVO 1 1/2" CAL 18 (aprx 100 pz/ kg)   | KG   | 1 1/2"   |
| ASH-0131 | CURVO 2" CAL 18 (aprx 47pz/ kg)         | KG   | 2"       |
| ASH-0132 | CURVO 2 1/2" CAL 18 (aprx 33 pz/ kg)    | KG   | 2 1/2"   |
| ASH-0133 | CURVO 3" CAL 18 (aprx 23 pz/ kg)        | KG   | 3"       |
| ASH-0134 | CURVO 4" CAL 18 (aprx 11 pz/ kg)        | KG   | 4"       |
| ASH-0135 | CURVO 6" CAL 18 (aprx 5 pz/ kg)         | KG   | 6"       |
| ASH-0136 | CURVO 8" CAL 18 (aprx 3 pz/ kg)         | KG   | 8"       |
| ASH-0137 | CHINO 1 1/2" CAL 18 (aprx 84 pz/ kg)    | KG   | 1 1/2"   |
| ASH-0138 | CHINO 2" CAL 18 (aprx 50 pz/ kg)        | KG   | 2"       |
| ASH-0139 | CHINO 2 1/2" CAL 18 (aprx 33 pz/ kg)    | KG   | 2 1/2"   |
| ASH-0140 | CHINO 3" CAL 18 (aprx 17pz/ kg)         | KG   | 3"       |
| ASH-0141 | CHINO 4" CAL 18 (aprx 12 pz/ kg)        | KG   | 4"       |
| ASH-0142 | CHINO 6" CAL 18 (aprx 5 pz/ kg)         | KG   | 6"       |
| ASH-0143 | CHINO 8" CAL 18 (aprx 3 pz/ kg)         | KG   | 8"       |
| ASH-0361 | LISO 1 1/2" CAL 18 (AP. 66 PZAS. X KG.) | KG   | 1 1/2"   |
| ASH-0362 | LISO 2" CAL 18                          | KG   | 2"       |
| ASH-0363 | LISO 3" CAL 18                          | KG   | 2 1/2"   |
| ASH-0364 | LISO 4" CAL 18 (13PZAS. X KG)           | KG   | 3"       |
| ASH-0365 | LISO 6" CAL.18 (6 PZAS. X KG)           | KG   | 4"       |
| ASH-0366 | LISO 2 1/2" CAL 18 3 PZ APROX           | KG   | 6"       |

ABASTECEDORA DE SOLDADURA Y HERRAJES S.A. DE C.V.

MIER Y NORIEGA No. 304 NTE. C.P. 67100 CD. GUADALUPE, N.L. MEXICO  
 Conmutador: (81) 83-54-83-45 Fax: (81) 83-54-83-45  
 admonventas@ashmex.com www.ashmex.com

ASH IMPORT & EXPORT LLC

601-E CEDAR AVE, SUITE E MC ALLEN, TX 78501 USA  
 PHONE/FAX : (956) 8004448 CELL PHONE: (956) 3880948  
 ashiecl@hotmail.com ashimportexport@gmail.com www.ashmex.com



Abastecedora de Soldadura y Herrajes



Fabricación  
Puntas de seguridad



## PUNTAS DE SEGURIDAD

| CODIGO    | DESCRIPCION  | LARGO |
|-----------|--|-------|
| ASH-0485X | PUNTA DE SEGURIDAD "HUIZACHE" 1 MTO. (NEGRA) CAL.12      | 1 M   |
| ASH-0414X | PUNTA DE SEGURIDAD "AGAVE CRUZADA" 1 MTO. (NEGRA) CAL.12 | 1 M   |
| ASH-0419X | PUNTA DE SEGURIDAD "LECHUGUILLA" 1 MTO. (NEGRA) CAL.12   | 1 M   |
| ASH-0415  | PUNTA DE SEGURIDAD "MAGUEY" 1 MTO. (NEGRA) CAL.12        | 1 M   |



## PUNTAS DE LAMINA TROQUELADA

| CODIGO   | DESCRIPCION                     | LARGO  | ANCHO  | PESO     |
|----------|---------------------------------|--------|--------|----------|
| ASH-0157 | COLONIAL DOBLE (AC. NATURAL)    | 2 3/4" | 1 1/2" | 0.032 KG |
| ASH-0182 | COLONIAL SENCILLA (AC. NATURAL) | 2 3/4" | 1 1/2" | 0.032 KG |



| CODIGO   | DESCRIPCION                   | LARGO | ANCHO  | PESO     |
|----------|-------------------------------|-------|--------|----------|
| ASH-0185 | DISNEY DOBLE (AC.NATURAL)     | 4"    | 1 3/4" | 0.032 KG |
| ASH-0186 | DISNEY SENCILLA (AC. NATURAL) | 4"    | 1 3/4" | 0.032 KG |



| CODIGO   | DESCRIPCION                  | LARGO | ANCHO  | PESO     |
|----------|------------------------------|-------|--------|----------|
| ASH-0004 | CUPIDO DOBLE (AC. NATURAL.)  | 4"    | 1 3/4" | 0.032 KG |
| ASH-0184 | CUPIDO SENCILLA (AC.NATURAL) | 4"    | 1 3/4" | 0.032 KG |



## PUNTA ORNAMENTAL EN SOLERA

| CODIGO   | DESCRIPCION                    | LARGO  | PESO     |
|----------|--------------------------------|--------|----------|
| ASH-0188 | PUNTA FLOR DE LIZ AC.PINT.NEGR | 4 1/4" | 0.080 KG |
| ASH-0189 | PUNTA LANZA AC.PINT.NEGRA      | 4 1/4" | 0.080 KG |
| ASH-0190 | PUNTA NAVE AC. PINT.NEGRA      | 4 1/4" | 0.050 KG |



| CODIGO   | DESCRIPCION                           |
|----------|---------------------------------------|
| ASH-0632 | PUNTA BAJIO TROQUELADA (ACERO) CAL 10 |





**Abastecedora de Soldadura y Herrajes**



**Fabricación  
Metal desplegado**

# METAL DESPLEGADO

**METAL- RED (MR)**  
**SIN PLANCHAR**

## TELA TIPO "C " (PAJARERA)

**PLANO- RED (PR)**  
**PLANCHADA**

| CODIGO    | DESCRIPCION                                 |
|-----------|---|
| ASHT-0269 | TELA PAJARERA C-20PR SECC.1.5 ROLLO 11 MTS. |
| ASHT-0267 | TELA PAJARERA C-22MR SECC.1.5 EN ROLLO      |
| ASHT-0316 | TELA PAJARERA C-22PR SECC. 1.5 EN ROLLO     |

ROLLO C/ 11 MTS

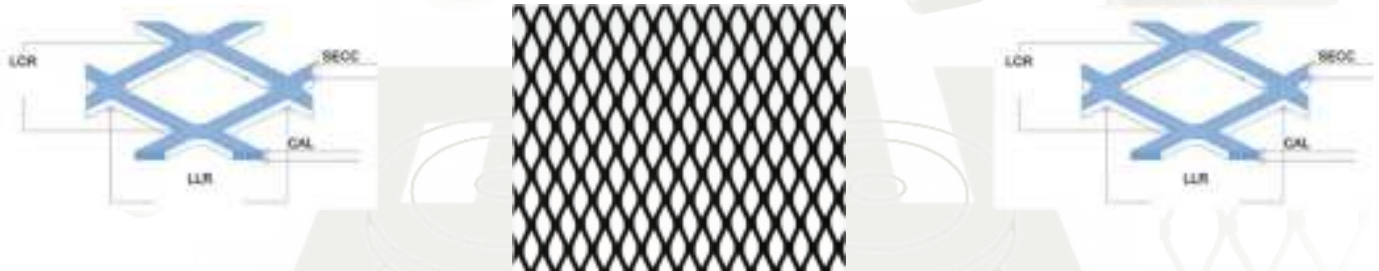

**METAL- RED (MR)**

## TELA TIPO " D "(PAJARERA)

**PLANO- RED (PR)**

| CODIGO    | DESCRIPCION                                 |
|-----------|---|
| ASHT-0255 | TELA PAJARERA D-16PR SECC.1.5 ROLLO 11 MTS. |
| ASHT-0270 | TELA PAJARERA D-18MR SECC.1.5 ROLLO 11 MTS  |
| ASHT-0254 | TELA PAJARERA D-18PR SECC.1.5 ROLLO 11 MTS. |
| ASHT-0253 | TELA PAJARERA D-20PR SECC.1.5 EN ROLLO      |
| ASHT-0252 | TELA PAJARERA D-22PR SECC.1.5 C/11MTS       |

ROLLO C/ 11 MTS

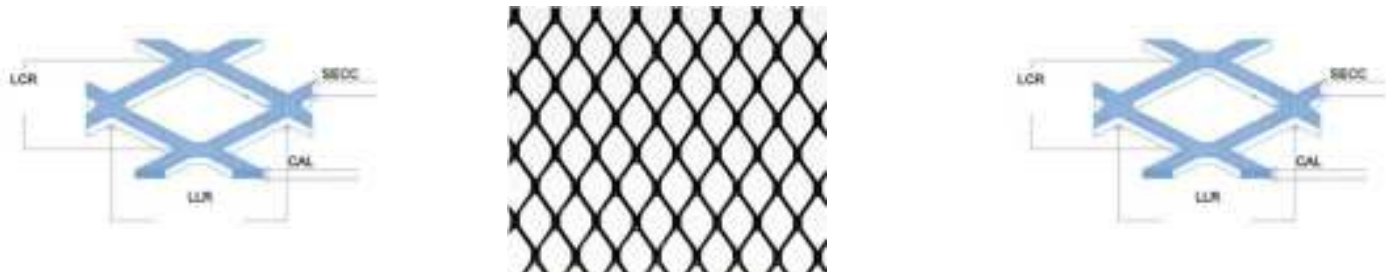

# METAL DESPLEGADO

## TELA TIPO E (MECEDORA) .91 CM

| CODIGO     | DESCRIPCION   |
|------------|---|
| ASHT-0330  | TELA PARA MECEDORA *E-16MR SECC.2.0 ROLLO (0.91 X 11 MTS) |
| ASHT-0069  | TELA PARA MECEDORA *E-16PR SECC.2.0 ROLLO (0.91 X 11 MTS) |
| ASHT-0211X | TELA PARA MECEDORA *E-18PR SECC.2.0 ROLLO (0.91 X 11 MTS) |
| ASHT-0082X | TELA PARA MECEDORA *E-20PR SECC.2.0 ROLLO (0.91 X 11 MTS) |
| ASHT-0054  | TELA PARA MECEDORA *E-22PR SECC.2.0 ROLLO (0.91 X 11 MTS) |
| ASHT-0019  | TELA PARA MECEDORA *E-22PR SECC.2.5 ROLLO (0.91 X 11 MTS) |
| ASHT-0007X | TELA PARA MECEDORA *E-22PR SECC.3.0 ROLLO (0.91 X 11 MTS) |

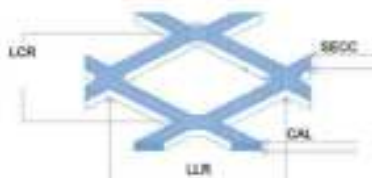

**PLANO- RED (PR)  
PLANCHADO**

**ROLLO  
0.91 MTS X 11 MTS**

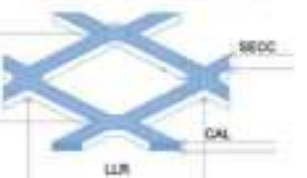

**METAL- RED (MR)  
SIN PLANCHAR**

## TELA TIPO E (MECEDORA) 1.20 CM

| CODIGO    | DESCRIPCION  |
|-----------|--|
| ASHT-0556 | TELA PARA MECEDORA E-16MR SECC.2.0 ROLLO (1.22 MTS X 11 MTS) |
| ASHT-0544 | TELA PARA MECEDORA E-16PR SECC.2.0 ROLLO (1.22 MTS X 11 MTS) |
| ASHT-0555 | TELA PARA MECEDORA E-18MR SECC.2.0 ROLLO (1.22 MTS x 11 MTS) |
| ASHT-0543 | TELA PARA MECEDORA E-18PR SECC.2.0 ROLLO (1.22 MTS X 11 MTS) |
| ASHT-0451 | TELA PARA MECEDORA E-20MR SEC.2.0 ROLLO (1.22 MTS X 11 MTS)  |
| ASHT-0542 | TELA PARA MECEDORA E-20PR SEC.2.0 ROLLO (1.22 MTS X 11 MTS)  |
| ASHT-0541 | TELA PARA MECEDORA E-22PR SECC.2.0 ROLLO (1.22 MTS X 11 MTS) |

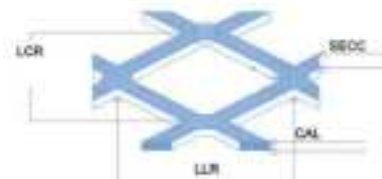

**PLANO- RED (PR)  
PLANCHADO**



**METAL- RED (MR)  
SIN PLANCHAR**

# METAL DESPLEGADO

## TELA TIPO G (TELA PARA ASADOR)

| CODIGO     | DESCRIPCION   |
|------------|---|
| ASHT-0004  | TELA PARA ASADOR *G-14MR SECC.2.5 ROLLO (0.91 X 11 MTS) |
| ASHT-0072X | TELA PARA ASADOR *G-14PR SECC.2.5 ROLLO (0.91 X 11 MTS) |
| ASHT-0063X | TELA PARA ASADOR *G-16MR SECC.2.5 ROLLO (0.91 X 11 MTS) |
| ASHT-0073X | TELA PARA ASADOR *G-16PR SECC.2.5 ROLLO (0.91 X 11 MTS) |
| ASHT-0062X | TELA PARA ASADOR *G-18MR SECC.2.5 ROLLO (0.91 X 11 MTS) |
| ASHT-0074X | TELA PARA ASADOR *G-18PR SECC.2.5 ROLLO (0.91 X 11 MTS) |
| ASHT-0326  | TELA PARA ASADOR *G-20MR SECC.2.5 ROLLO (0.91 X 11 MTS) |
| ASHT-0075X | TELA PARA ASADOR *G-20PR SECC.2.5 ROLLO (0.91 X 11 MTS) |

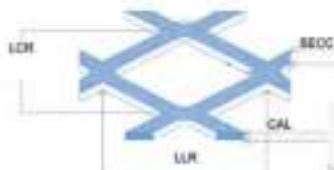

**PLANO- RED (PR)  
PLANCHADO**

**ROLLO  
(0.91 X 11 MTS)**

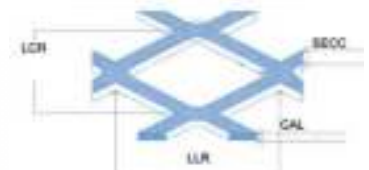

**METAL- RED (MR)  
SIN PLANCHAR**

## TELA TIPO G (TELA PARA ASADOR)

| CODIGO    | DESCRIPCION  |
|-----------|--|
| ASHT-0353 | TELA PARA ASADOR G-14MR SECC.2.5 ROLLO (1.22 MTS X 11 MTS) |
| ASHT-0354 | TELA PARA ASADOR G-14PR SECC.2.5 ROLLO (1.22 MTS X 11 MTS) |
| ASHT-0349 | TELA PARA ASADOR G-16MR SECC.2.5 ROLLO (1.22 MTS X 11 MTS) |
| ASHT-0350 | TELA PARA ASADOR G-16PR SECC.2.5 ROLLO (1.22 MTS X 11 MTS) |
| ASHT-0351 | TELA PARA ASADOR G-18MR SECC.2.5 ROLLO (1.22 MTS X 11 MTS) |
| ASHT-0352 | TELA PARA ASADOR G-18PR SECC.2.5 ROLLO (1.22 MTS X 11 MTS) |
| ASHT-0540 | TELA PARA ASADOR G-20MR SECC.2.5 ROLLO (1.22 MTS X 11 MTS) |
| ASHT-0338 | TELA PARA ASADOR G-20PR SECC.2.5 ROLLO (1.22 MTS X 11 MTS) |

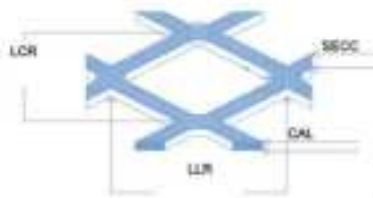

**PLANO- RED (PR)  
PLANCHADO**

**ROLLO  
(1.22 X 11 MTS)**

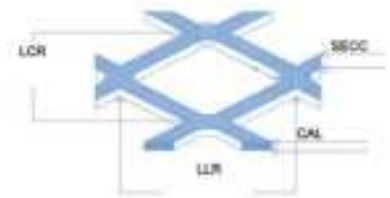

**METAL- RED (MR)  
SIN PLANCHAR**



# METAL DESPLEGADO

## TELA TIPO H (TELA PARA ASADOR)

| CODIGO     | NOMBRE  |
|------------|---|
| ASHT-0009X | TELA PARA ASADOR *H-12MR SECC.3 ROLLO (0.91 X 11 MTS) |
| ASHT-0230X | TELA PARA ASADOR *H-12PR SECC.3 ROLLO (0.91 X 11 MTS) |
| ASHT-0052X | TELA PARA ASADOR *H-14MR SECC.3 ROLLO (0.91 X 11 MTS) |
| ASHT-0076X | TELA PARA ASADOR *H-14PR SECC.3 ROLLO (0.91 X 11 MTS) |
| ASHT-0321  | TELA PARA ASADOR *H-16MR SECC.3 ROLLO (0.91 X 11 MTS) |
| ASHT-0318  | TELA PARA ASADOR *H-16PR SECC.3 ROLLO (0.91 X 11 MTS) |
| ASHT-0322  | TELA PARA ASADOR *H-18MR SECC.3 ROLLO (0.91 X 11 MTS) |
| ASHT-0323  | TELA PARA ASADOR *H-18PR SECC.3 ROLLO (0.91 X 11 MTS) |
| ASHT-0328  | TELA PARA ASADOR *H-20MR SECC.3 ROLLO (0.91 X 11 MTS) |
| ASHT-0329  | TELA PARA ASADOR *H-20PR SECC.3 ROLLO (0.91 X 11 MTS) |

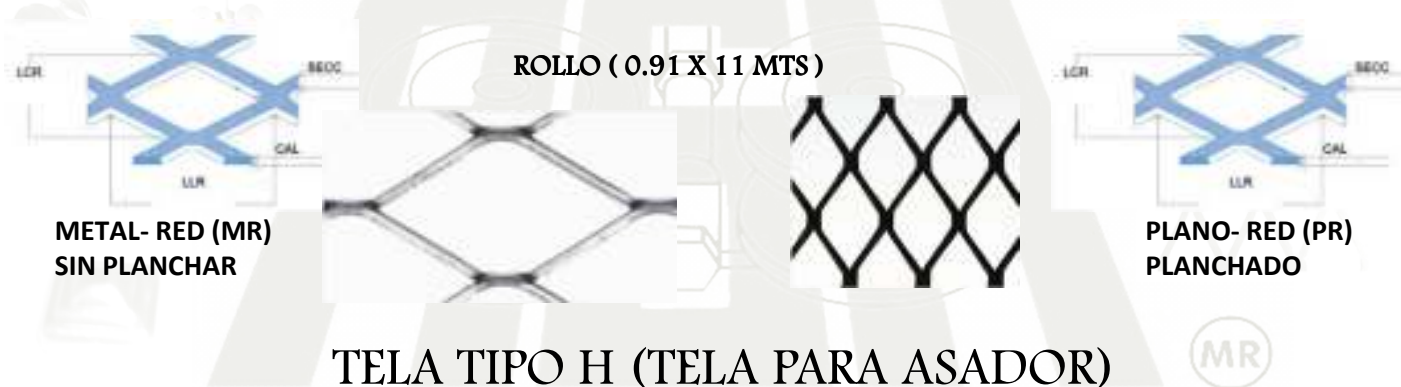

| CODIGO    | DESCRIPCION  |
|-----------|--|
| ASHT-0551 | TELA PARA ASADOR H-12MR SECC.3 ROLLO (1.22 MTS X 11 MTS) |
| ASHT-0546 | TELA PARA ASADOR H-12PR SECC.3 ROLLO (1.22 MTS X 11 MTS) |
| ASHT-0558 | TELA PARA ASADOR H-14MR SECC.3 ROLLO (1.22 MTS X 11 MTS) |
| ASHT-0557 | TELA PARA ASADOR H-14PR SECC.3 ROLLO (1.22 MTS X 11 MTS) |

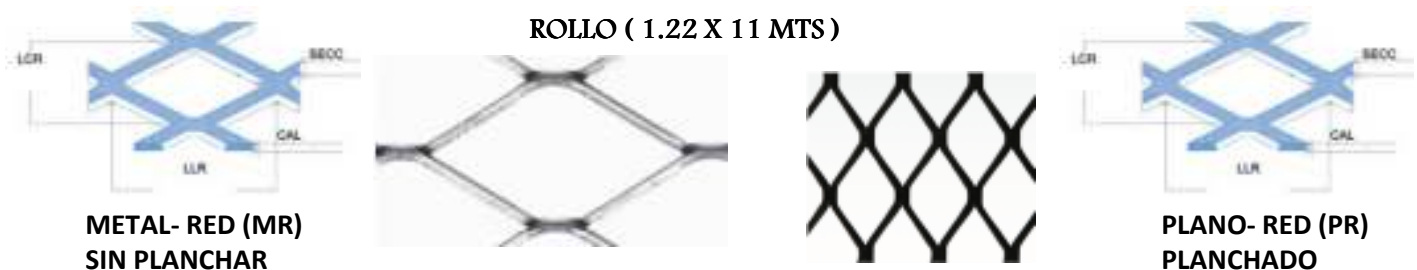

# METAL DESPLEGADO

## TELA TIPO J (TELA PARA ASADOR)

| CODIGO     | DESCRIPCION   |
|------------|---|
| ASHT-0196X | TELA PARA ASADOR *J-10MR SECC.3 ROLLO (0.91 X 11 MTS)   |
| ASHT-0005X | TELA PARA ASADOR *J-10MR SECC.4 ROLLO (0.91 X 11 MTS)   |
| ASHT-0549  | TELA PARA ASADOR *J-10PR SECC.3.5 ROLLO (0.91 X 11 MTS) |
| ASHT-0305X | TELA PARA ASADOR *J-10PR SECC.4 ROLLO (0.91 X 11 MTS)   |
| ASHT-0194X | TELA PARA ASADOR *J-12MR SECC.3 ROLLO (0.91 X 11 MTS)   |
| ASHT-0003X | TELA PARA ASADOR *J-12MR SECC.4 ROLLO (0.91 X 11 MTS)   |
| ASHT-0238X | TELA PARA ASADOR *J-12PR SECC.3 ROLLO (0.91 X 11 MTS)   |
| ASHT-0239X | TELA PARA ASADOR *J-12PR SECC.4 ROLLO (0.91 X 11 MTS)   |
| ASHT-0536  | TELA PARA ASADOR *J-L14MR SECC 3 ROLLO (0.91 X 11 MTS)  |
| ASHT-0538  | TELA PARA ASADOR *J-L14MR SECC 4 ROLLO (0.91 X 11 MTS)  |
| ASHT-0537  | TELA PARA ASADOR *J-L14PR SECC 3 ROLLO (0.91 X 11 MTS)  |
| ASHT-0539  | TELA PARA ASADOR *J-L14PR SECC 4 ROLLO (0.91 X 11 MTS)  |

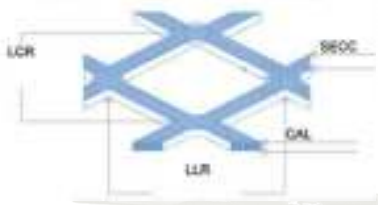

**PLANO- RED (PR)  
PLANCHADO**

**ROLLO ( 0.91 X 11 MTS )**

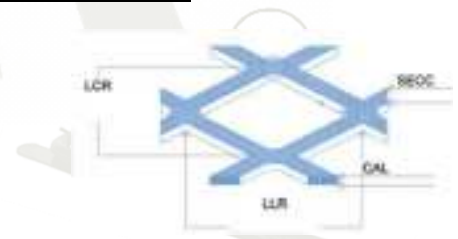

**METAL- RED (MR)  
SIN PLANCHAR**

## TELA TIPO J (TELA PARA ASADOR)

| CODIGO    | DESCRIPCION  |
|-----------|--|
| ASHT-0344 | TELA PARA ASADOR J-12MR SECC.3 ROLLO (1.22 MTS X 11 MTS) |
| ASHT-0348 | TELA PARA ASADOR J-12MR SECC.4 ROLLO (1.22 MTS X 11 MTS) |
| ASHT-0553 | TELA PARA ASADOR J-12PR SECC.3 ROLLO (1.22 MTS X 11 MTS) |

**ROLLO ( 1.22 X 11 MTS )**

# MOSQUI-RED CAL. 26 GALV.

HOJA 3' X 7' FT. 91MTS. X 2.13 MTS

ROLLO (. 91MTS. X 11 MTS

| CODIGO    | NOMBRE   |
|-----------|--|
| ASHT-0053 | MOSQUI-RED GALV "HOJA"3 FT 0.91 X2.13 CAL-26 SECC. 0.5 |
| ASHT-0198 | MOSQUI-RED GALV ROLLO 3 FT X 11 MTS CAL-26 SECC. 0.5   |

# MOSQUI-RED CAL. 26 NEGRA.

HOJA 3' X 7' FT. 91MTS. X 2.13 MTS

ROLLO (. 91MTS. X 11 MTS

| CODIGO    | NOMBRE   |
|-----------|--|
| ASHT-0197 | MOSQUI-RED NEGRA ROLLO 3 FT X 11 MTS CAL-26 SECC. 0.5        |
| ASHT-0011 | MOSQUI-RED NEGRA "HOJA"3 FT 91MTS. X 2.13 MTS.CAL-26 SECC. 0 |



Negra



Galvanizada

## TELA PLAFONERA



ROLLO C/22 MTS.

| CODIGO     | NOMBRE   |
|------------|--|
| ASHT-0057X | TELA PLAFONERA NEGRA "ROLLO" SECC.600 C/22 MTS. CAL 26 |





**METAL DESPLEGADO (PLANCHADO) ACERO AL CARBON ASH**

| PRODUCTO | CALIBRE | ESPEJOR<br>DESPUES<br>DE PLANCHAR | PESO    | SECCIÓN | ABERTURA DE<br>LA MALLA (mm) | DIMENSION DEL<br>ROLLO (mts.) |
|----------|---------|-----------------------------------|---------|---------|------------------------------|-------------------------------|
|          |         | (mm)                              | (kg/m2) | (mm)    | LCR x LLR                    | LCR x LLR                     |
| B-26 PR  | 26      | 0.45                              | 1.31    | 1       | 5.20 X 9.90                  | 11.00 X 0.915                 |
| B-24 PR  | 24      | 0.61                              | 1.76    | 1       | 5.20 X 9.90                  | 11.00 X 0.915                 |
| B-22 PR  | 22      | 0.76                              | 2.20    | 1       | 5.20 X 9.90                  | 11.00 X 0.915                 |
| B-20 PR  | 20      | 0.91                              | 2.64    | 1       | 5.20 X 9.90                  | 11.00 X 0.915                 |
| C-26 PR  | 26      | 0.45                              | 0.90    | 1       | 8.70 X 15.80                 | 11.00 X 0.915                 |
| C-24 PR  | 24      | 0.61                              | 1.20    | 1       | 8.70 X 15.80                 | 11.00 X 0.915                 |
| C-22 PR  | 22      | 0.76                              | 2.30    | 1.5     | 8.70 X 15.80                 | 11.00 X 0.915                 |
| C-20 PR  | 20      | 0.91                              | 2.77    | 1.5     | 8.70 X 15.80                 | 11.00 X 0.915                 |
| D-24 PR  | 24      | 0.61                              | 1.35    | 1.5     | 12.10 X 22.20                | 11.00 X 0.915                 |
| D-22 PR  | 22      | 0.76                              | 1.70    | 1.5     | 12.10 X 22.20                | 11.00 X 0.915                 |
| D-20 PR  | 20      | 0.91                              | 2.00    | 1.5     | 12.10 X 22.20                | 11.00 X 0.915                 |
| D-18 PR  | 18      | 1.21                              | 2.70    | 1.5     | 12.10 X 22.20                | 11.00 X 0.915                 |
| D-16 PR  | 16      | 1.52                              | 3.35    | 1.5     | 12.10 X 22.20                | 11.00 X 0.915                 |
| E-22 PR  | 22      | 0.76                              | 2.00    | 2       | 14.61 X 31.24                | 11.00 X 0.915                 |
| E-20 PR  | 20      | 0.91                              | 2.40    | 2       | 14.61 X 31.24                | 11.00 X 0.915                 |
| E-18 PR  | 18      | 1.21                              | 3.25    | 2       | 14.61 X 31.24                | 11.00 X 0.915                 |
| E-16 PR  | 16      | 1.52                              | 4.10    | 2       | 14.61 X 31.24                | 11.00 X 0.915                 |
| E-14 PR  | 14      | 1.9                               | 5.10    | 2       | 14.61 X 31.24                | 11.00 X 0.915                 |
| G-20 PR  | 20      | 0.91                              | 1.62    | 2.5     | 22.23 X 41.28                | 11.00 X 0.915                 |
| G-18 PR  | 18      | 1.21                              | 2.16    | 2.5     | 22.23 X 41.28                | 11.00 X 0.915                 |
| G-16 PR  | 16      | 1.52                              | 2.70    | 2.5     | 22.23 X 41.28                | 11.00 X 0.915                 |
| G-14 PR  | 14      | 1.9                               | 3.42    | 2.5     | 22.23 X 41.28                | 11.00 X 0.915                 |
| G-12 PR  | 12      | 2.28                              | -----   | 3       | 22.23 X 41.28                | 11.00 X 0.915                 |
| G-10 PR  | 10      | 3.42                              | -----   | 3       | 22.23 X 41.28                | 11.00 X 0.915                 |
| G-9 PR   | 9       | -----                             | -----   | 4       | 22.23 X 41.28                | 1.23 X 0.60                   |
| H-20 PR  | 20      | 0.91                              | 1.58    | 3       | 26.97 X 50.80                | 11.00 X 0.915                 |
| H-18 PR  | 18      | 1.21                              | 2.07    | 3       | 26.97 X 50.80                | 11.00 X 0.915                 |
| H-16 PR  | 16      | 1.52                              | 2.61    | 3       | 26.97 X 50.80                | 11.00 X 0.915                 |
| H-14 PR  | 14      | 1.9                               | 3.24    | 3       | 26.97 X 50.80                | 11.00 X 0.915                 |
| H-12 PR  | 12      | 2.28                              | 4.64    | 3       | 26.97 X 50.80                | 11.00 X 0.915                 |
| H-10 PR  | 10      | 3.42                              | -----   | 3       | 26.97 X 50.80                | 11.00 X 0.915                 |
| J-16 PR  | 16      | 1.52                              | 2.52    | 4       | 38.10 X 69.85                | 11.00 X 0.915                 |
| J-14 PR  | 14      | 1.9                               | 3.15    | 4       | 38.10 X 69.85                | 11.00 X 0.915                 |
| J-12 PR  | 12      | 2.28                              | 4.35    | 3.2     | 38.10 X 69.85                | 11.00 X 0.915                 |
| J-10 PR  | 10      | 3.42                              | 5.54    | 3.8     | 38.10 X 69.85                | 11.00 X 0.915                 |

EL METAL DESPLEGADO DE ASH SE FABRICA EN ROLLOS DE 11 MTS, LOS ROLLOS DE MECEDORA Y PLAFON VIENEN EN ROLLOS DE 22 MTS.

NOTA: EL METAL DESPLEGADO ES APROX. 4% MAS PESADO QUE LA LAMINA DE ACERO AL CARBÓN  
 EL METAL DESPLEGADO PLANCHADO ES APROX. 10% MAS LIVIANO QUE EL METAL DESPLEGADO ESTANDAR.  
 ABREVIATURAS: **LCR: LADO CORTO DEL ROMBO; LLR LARGO DEL ROMBO.**

TODOS LOS PRODUCTOS MENCIONADOS CUMPLEN CON TODAS LAS NORMAS.



**METAL DESPLEGADO (SIN PLANCHAR) ACERO AL CARBON ASH**

| PRODUCTO | CALIBRE | ESPESOR<br>DESPUES<br>DE PLANCHAR | PESO    | SECCIÓN | ABERTURA DE<br>LA MALLA (mm) | DIMENSION DEL<br>ROLLO (mts.) |
|----------|---------|-----------------------------------|---------|---------|------------------------------|-------------------------------|
|          |         | (mm)                              | (kg/m2) | (mm)    | LCR x LLR                    | LCR x LLR                     |
| B-26 MR  | 26      | 0.45                              | 1.45    | 1       | 4.70 X 9.90                  | 11.00 X 0.915                 |
| B-24 MR  | 24      | 0.61                              | 1.95    | 1       | 4.70 X 9.90                  | 11.00 X 0.915                 |
| B-22 MR  | 22      | 0.76                              | 2.44    | 1       | 4.70 X 9.90                  | 11.00 X 0.915                 |
| B-20 MR  | 20      | 0.91                              | 2.93    | 1       | 4.70 X 9.90                  | 11.00 X 0.915                 |
| C-26 MR  | 26      | 0.45                              | 0.9     | 1       | 7.90 X 15.80                 | 11.00 X 0.915                 |
| C-24 MR  | 24      | 0.61                              | 1.2     | 1       | 7.90 X 15.80                 | 11.00 X 0.915                 |
| C-22 MR  | 22      | 0.76                              | 2.3     | 1.5     | 7.90 X 15.80                 | 11.00 X 0.915                 |
| C-20 MR  | 20      | 0.91                              | 2.77    | 1.5     | 7.90 X 15.80                 | 11.00 X 0.915                 |
| D-24 MR  | 24      | 0.61                              | 1.35    | 1.5     | 11.10 x 22.23                | 11.00 X 0.915                 |
| D-22 MR  | 22      | 0.76                              | 1.7     | 1.5     | 11.10 x 22.23                | 11.00 X 0.915                 |
| D-20 MR  | 20      | 0.91                              | 2       | 1.5     | 11.10 x 22.23                | 11.00 X 0.915                 |
| D-18 MR  | 18      | 1.21                              | 2.7     | 1.5     | 11.10 x 22.23                | 11.00 X 0.915                 |
| D-16 MR  | 16      | 1.52                              | 3.35    | 1.5     | 11.10 x 22.23                | 11.00 X 0.915                 |
| E-22 MR  | 22      | 0.76                              | 2       | 2       | 12.70 x 31.24                | 11.00 X 0.915                 |
| E-20 MR  | 20      | 0.91                              | 2.4     | 2       | 12.70 x 31.24                | 11.00 X 0.915                 |
| E-18 MR  | 18      | 1.21                              | 3.25    | 2       | 12.70 x 31.24                | 11.00 X 0.915                 |
| E-16 MR  | 16      | 1.52                              | 4.1     | 2       | 12.70 x 31.24                | 11.00 X 0.915                 |
| E-14 MR  | 14      | 1.9                               | 5.1     | 2       | 12.70 x 31.24                | 11.00 X 0.915                 |
| G-20 MR  | 20      | 0.91                              | 1.8     | 2.5     | 19.05 X 41.28                | 11.00 X 0.915                 |
| G-18 MR  | 18      | 1.21                              | 2.4     | 2.5     | 19.05 X 41.28                | 11.00 X 0.915                 |
| G-16 MR  | 16      | 1.52                              | 3       | 2.5     | 19.05 X 41.28                | 11.00 X 0.915                 |
| G-14 MR  | 14      | 1.9                               | 3.8     | 2.5     | 19.05 X 41.28                | 11.00 X 0.915                 |
| G-12 MR  | 12      | 2.66                              | ----    | 3       | 19.05 X 41.28                | 11.00 X 0.915                 |
| G-10 MR  | 10      | 3.42                              | ----    | 3       | 19.05 X 41.28                | 11.00 X 0.915                 |
| G-9 MR   | 9       | ----                              | ----    | 4       | 19.05 X 41.28                | 11.00 X 0.915                 |
| H-20 MR  | 20      | 0.91                              | 1.75    | 3       | 23.80 X 50.80                | 11.00 X 0.915                 |
| H-18 MR  | 18      | 1.21                              | 2.3     | 3       | 23.80 X 50.80                | 11.00 X 0.915                 |
| H-16 MR  | 16      | 1.52                              | 2.9     | 3       | 23.80 X 50.80                | 11.00 X 0.915                 |
| H-14 MR  | 14      | 1.9                               | 3.6     | 3       | 23.80 X 50.80                | 11.00 X 0.915                 |
| H-12 MR  | 12      | 2.66                              | 5.15    | 3       | 23.80 X 50.80                | 11.00 X 0.915                 |
| H-10 MR  | 10      | 3.42                              | ----    | 3       | 23.80 X 50.80                | 11.00 X 0.915                 |
| J-16 MR  | 16      | 1.52                              | 2.8     | 4       | 33.81 X 69.85                | 11.00 X 0.915                 |
| J-14 MR  | 14      | 1.9                               | 3.5     | 4       | 33.81 X 69.85                | 11.00 X 0.915                 |
| J-12 MR  | 12      | 2.66                              | 4.9     | 4       | 33.81 X 69.85                | 11.00 X 0.915                 |
| J-10 MR  | 10      | 3.42                              | 6.25    | 4       | 33.81 X 69.85                | 11.00 X 0.915                 |

EL METAL DESPLEGADO DE ASH SE FABRICA EN ROLLOS DE 11 MTS, LOS ROLLOS DE MECEDORA Y PLAFON VIENEN EN ROLLOS DE 22 MTS.

NOTA: EL METAL DESPLEGADO ES APROX. 4% MAS PESADO QUE LA LAMINA DE ACERO AL CARBÓN  
EL METAL DESPLEGADO PLANCHADO ES APROX. 10% MAS LIVIANO QUE EL METAL DESPLEGADO ESTANDAR.

ABREVIATURAS: LCR: LADO CORTO DEL ROMBO; LLR LARGO DEL ROMBO.

TODOS LOS PRODUCTOS MENCIONADOS CUMPLEN CON TODAS LAS NORMAS.



Abastecedora de Soldadura y Herrajes



Fabricación de Forja  
y Solera

# SOLERA PERFORADA

| CODIGO     | DESCRIPCION                         | LARGO   | ANCHO  | CALIBRE | CALIBRE MM |
|------------|-------------------------------------|---------|--------|---------|------------|
| ASFC-0401X | SOLERA 3MT. PERF.P/ Ø 1/2" (12CM)   | 3.048 M | 1 1/4" | 3/16"   | 0.187      |
| ASFC-0413  | SOLERA 3MT. PERF.P/ Ø 1/2" (14CM)   | 3.048 M | 1 1/4" | 3/16"   | 0.187      |
| ASFC-0409  | SOLERA 3MT. PERF.P/ Ø 1/2" (16CM)   | 3.048 M | 1 1/4" | 3/16"   | 0.187      |
| ASFC-0415  | SOLERA 3MT. PERF.P/ Ø 3/4" (14CM)   | 3.048 M | 1 1/4" | 3/16"   | 0.187      |
| ASFC-0403X | SOLERA 3MT. PERF.P/ Ø 5/8" (12CM)   | 3.048 M | 1 1/4" | 3/16"   | 0.187      |
| ASFC-0414  | SOLERA 3MT. PERF.P/ Ø 5/8" (14CM)   | 3.048 M | 1 1/4" | 3/16"   | 0.187      |
| ASFC-0417  | SOLERA 3MT. PERF.P/ Ø 5/8" (16CM)   | 3.048 M | 1 1/4" | 3/16"   | 0.187      |
| ASFC-0400X | SOLERA 3MT. PERF.P/[ ] 1/2" (12CM)  | 3.048 M | 1 1/4" | 3/16"   | 0.187      |
| ASFC-0410  | SOLERA 3MT. PERF.P/[ ] 1/2" (14 CM) | 3.048 M | 1 1/4" | 3/16"   | 0.187      |
| ASFC-0404X | SOLERA 3MT. PERF.P/[ ] 1/2" (16CM)  | 3.048 M | 1 1/4" | 3/16"   | 0.187      |
| ASH-0686X  | SOLERA 3MT. PERF.P/[ ] 3/4" (12CM)  | 3.048 M | 1 1/4" | 3/16"   | 0.187      |
| ASFC-0412  | SOLERA 3MT. PERF.P/[ ] 3/4" (14 CM) | 3.048 M | 1 1/4" | 3/16"   | 0.187      |
| ASFC-0416  | SOLERA 3MT. PERF.P/[ ] 3/4" (16 CM) | 3.048 M | 1 1/4" | 3/16"   | 0.187      |
| ASFC-0402X | SOLERA 3MT. PERF.P/[ ] 5/8" (12CM)  | 3.048 M | 1 1/4" | 3/16"   | 0.187      |
| ASFC-0411  | SOLERA 3MT. PERF.P/[ ] 5/8" (14 CM) | 3.048 M | 1 1/4" | 3/16"   | 0.187      |
| ASFC-0418  | SOLERA 3MT. PERF.P/[ ] 5/8" (16 CM) | 3.048 M | 1 1/4" | 3/16"   | 0.187      |

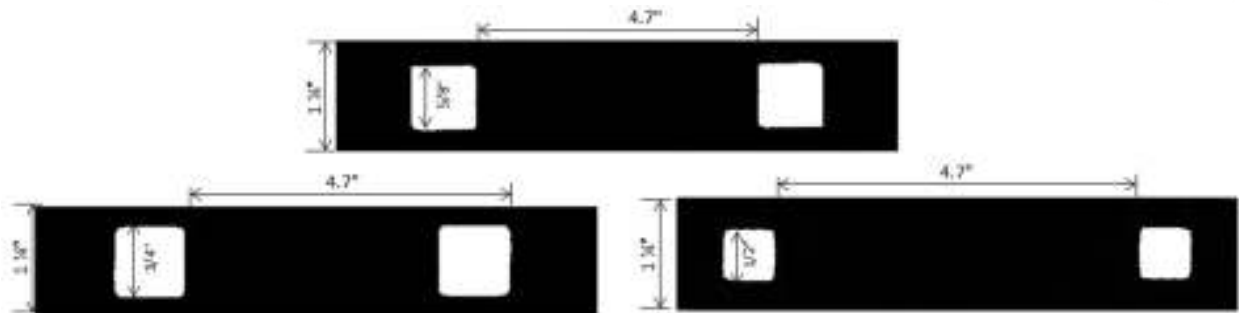

ABASTECEDORA DE SOLDADURA Y HERRAJES S.A. DE C.V.  
 MIER Y NORIEGA No. 304 NTE. C.P. 67100 CD. GUADALUPE, N.L. MEXICO  
 Conmutador: (81) 83-54-83-45 Fax: (81) 83-54-83-45  
 admonventas@ashmex.com www.ashmex.com

ASH IMPORT & EXPORT LLC  
 601-E CEDAR AVE, SUITE E MC ALLEN, TX 78501 USA  
 PHONE/FAX : (956) 8004448 CELL PHONE: (956) 3880948  
 ashiellc@hotmail.com ashimportexport@gmail.com www.ashmex.com

# FORJA CUADRADA Y REDONDA

| CODIGO     | DESCRIPCION  | CALIBRE |
|------------|--|---------|
| ASFC-0009X | FORJA A-09 (C-09) 12 X 63.5 CM. [ ] 1/2" 1.350KG.            | 1/2"    |
| ASFC-0001  | FORJA A-1 (C-01) 12 X 17 CM. [ ] 1/2" 0.420KG.               |         |
| ASFC-0011  | FORJA A-11 (C-11) 12 X 63.5 CM. [ ] 1/2" 1.200KG             |         |
| ASFC-0012X | FORJA A-12 (C-12) 11 X 49 CM.A 15 X 49 CM. [ ] 1/2" 1.300KG  |         |
| ASFC-0013X | FORJA A-13 (C-13) 12 X 33 CM. [ ] 1/2" 0.820KG.              | 1/2"    |
| ASFC-0014X | FORJA A-14 (C-14) 12 X 32.5 CM. [ ] 1/2" SIN TORSION 0.840KG | 1/2"    |
| ASFC-0015  | FORJA A-15 (C-15) 12 X 28 CM. [ ] 1/2" SIN TORSION 0.840KG   | 1/2"    |
| ASFC-1515  | FORJA A-15T (C-15) 12 X 28 CM. [ ] 1/2" CON TORSION 0.840KG  | 1/2"    |
| ASFC-0016X | FORJA A-16 (C-16) 12 X 37.5 CM. [ ] 1/2" 0.9700 KG           | 1/2"    |
| ASFC-0002X | FORJA A-2 (C-02) 12 X 21CM. [ ] 1/2" 0.795KG.                | 1/2"    |
| ASFC-0005  | FORJA A-5 (C-3) ARO "O" 12CM. (AC. NEG.) [ ] 1/2" 0.400 KG.  | 1/2"    |
| ASFC-0512X | FORJA A-5C (C-5) "U" CHICA 12 X 12 CM. [ ] 1/2" 0.440KG.     | 1/2"    |
| ASFC-0518X | FORJA A-5G (C-5) "U" GRANDE 12 X 18 CM. [ ] 1/2" 0.514KG.    | 1/2"    |
| ASFC-0006X | FORJA A-6 (C-4) ARO "O" 16CM. (AC. NEG.) [ ] 1/2" 0.500KG.   | 1/2"    |
| ASFC-0007  | FORJA A-7 (C-07) 12 X 37.5 CM. [ ] 1/2" SIN TORSION 0.890KG  | 1/2"    |
| ASFC-0077X | FORJA A-7T (C-07) 12 X 37.5 CM.[ ] 1/2" CON TORSION 0.950KG  | 1/2"    |
| ASFC-0008X | FORJA A-8 (C-08) 12 X 33 CM. [ ] 1/2" SIN TORSION 0.950 KG   | 1/2"    |
| ASFC-0088X | FORJA A-8T (C-08) 12 X 33 CM. [ ] 1/2" CON TORSION 0.920KG   | 1/2"    |
| ASFC-0022  | FORJA ARO 12 CM. "SOLERA 1/2" CAL. 9" C/10 PZAS X KG. APROX. | 1/2"    |
| ASFC-0022X | FORJA ARO 12 CM. "SOLERA 1/2" K CAL. 9" (POR PIEZA).         | 1/2"    |
| ASFC-0078  | FORJA ARO 16 CM. "SOLERA 1/2" CALIBRE 9"                     | 1/2"    |
| ASFC-0003X | FORJA ARO C-3 12 CM REDONDO DE 1/2" 0.334KG.                 | 1/2"    |
| ASFC-0004X | FORJA ARO C-4 16 CM REDONDO DE 1/2" 0.460KG.                 | 1/2"    |
| ASFC-0619  | FORJA B-02 (21 X 12 CM)                                      | 1/2"    |
| ASFC-620   | FORJA B-9 (1.010 KG)   | 1/2"    |
| ASFC-0614X | FORJA C-6 "U" CHICA 16 X 14 CM. [ ] 1/2" 0.350               | 1/2"    |
| ASFC-0618X | FORJA C-6 "U" GRANDE 16 X 18 CM. [ ] 1/2" 0.520KG.           | 1/2"    |

ABASTECEDORA DE SOLDADURA Y HERRAJES S.A. DE C.V.  
 MIER Y NORIEGA No. 304 NTE. C.P. 67100 CD. GUADALUPE, N.L. MEXICO  
 Conmutador: (81) 83-54-83-45 Fax: (81) 83-54-83-45  
 admonventas@ashmex.com www.ashmex.com

ASH IMPORT & EXPORT LLC  
 601-E CEDAR AVE, SUITE E MC ALLEN, TX 78501 USA  
 PHONE/FAX : (956) 8004448 CELL PHONE: (956) 3880948  
 ashiellc@hotmail.com ashimportexport@gmail.com www.ashmex.com



**ASFC-0001**



**ASFC-0002**



**ASFC-0007**



**ASFC-0009**



**ASFC-0010**



**ASFC-0011**



**ASFC-0008**



**ASFC-0012**



**ASFC-0013**



**ASFC-0014**



**ASFC-0015**



**ASFC-0016**



**ASFC-0088**



**ASFC-1515**



**ASFC-0077**



**ASFC-0006**



**ASFC-0004**



**ASFC-0518**



**ASFC-0005**



**ASFC-0003**



**ASFC-0512**



**ABASTECEDORA DE SOLDADURA Y HERRAJES S.A. DE C.V.**  
**MIER Y NORIEGA No. 304 NTE. C.P. 67100 CD. GUADALUPE, N.L. MEXICO**  
**Conmutador: (81) 83-54-83-45 Fax: (81) 83-54-83-46**  
**admonventas@ashmex.com www.ashmex.com**