

Abastecedora de Soldadura y Herrajes

C
A
T
A
L
O
G
O

2
0
2
3



Fabricación De Herrajes.

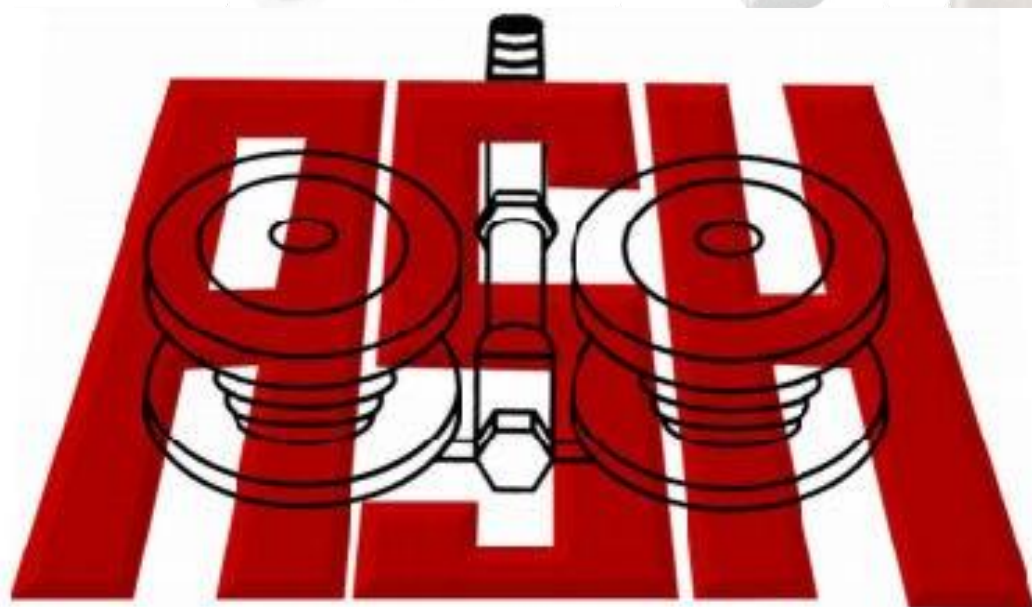
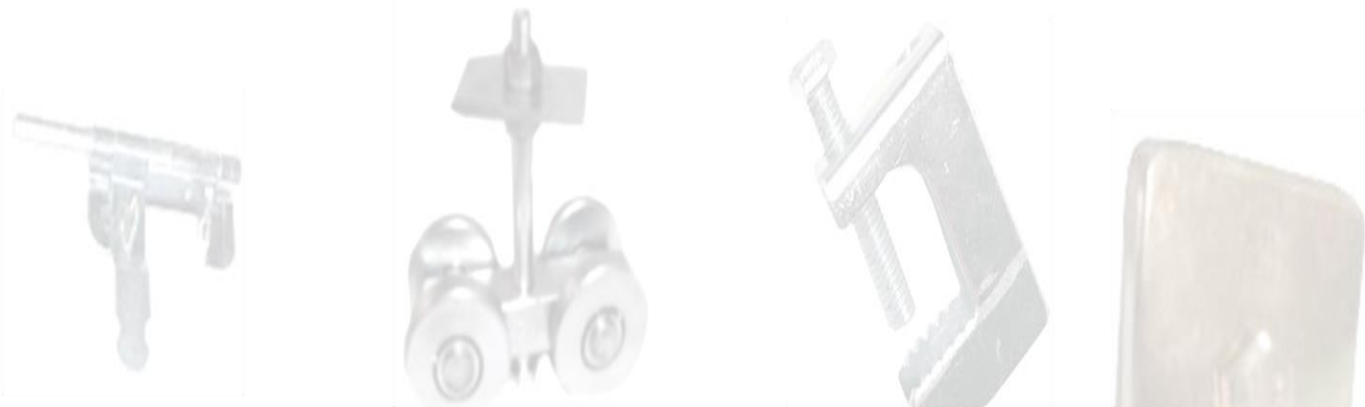

ABASTECEDORA DE SOLDADURA Y HERRAJES S.A. DE C.V.

FABRICANTES DE HERRAJES, METAL DESPLEGADO, TORNILLERIA,
EXPANSORES Y FUNDICION DE FIERRO VACIADO, ALUMINIO Y BRONCE

MIER Y NORIEGA No. 304 NTE. C.P. 67100 CD.GUADALUPE, N.L. MEXICO

TELS: 8354-8345, 8354-8346, 8354-8348 Y 8354-8359 FAX: 8354-8385

ashmexsa@yahoo.com www.ashmex.com

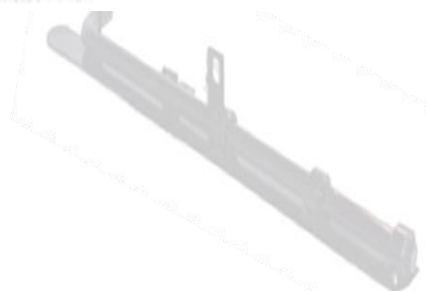

**I
N
S
T
A
L
A
C
I
O
N
E
S**

EQUIPO ASH



SALA DE EXHIBICION Y VENTAS

**PLANTA
MAS DE 8000 m2
PRODUCIENDO PARA
USTED**



**INGENIERIA Y
MANTENIMIENTO
PROPIOS**



**AREAS DE
METAL
DESPLIEGADO**



**AMPLIOS ALMACENES
QUE OFRECEN GRAN
SURTIDO**

**ATENCION A
OBREROS
Y EMPLEADOS**



**AREA DE
GALVANIZADO
ECOLOGICO NO
CONTAMINANTE**



**AREAS DE
TORNOS AUTOMATICOS**



**1 DE LAS 3 AREAS
DE TROQUELADO**

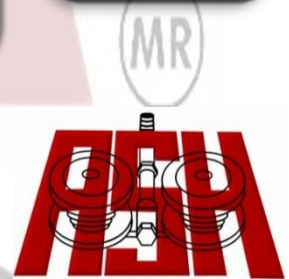

TAQUETE EXPANSOR



CODIGO	DESCRIPCION	PESO	DIAMETRO	LARGO
ASH-0520	"TX" CON TORNILLO (6.35MM.) 1/4"	0.030 Kg	1/4"	2 1/2"
ASH-0521	"TX" CON TORNILLO (7.93MM.) 5/16"	0.040 Kg	5/16"	2 1/2"
ASH-0522	"TX" CON TORNILLO (9.52MM.) 3/8"	0.060 Kg	3/8"	3"
ASH-0531	"TX" CON TORNILLO (12.7MM.) 1/2"	0.120 Kg	1/2"	3 1/4"
ASH-0532	"TX" CON TORNILLO (15.87MM.) 5/8"	0.210 Kg	5/8"	4 "
ASH-0533	"TX" CON TORNILLO (19.05MM.) 3/4"	0.380 Kg	3/4"	5 1/2"

PLACA BASE SOLDABLE

CODIGO	DESCRIPCION	LARGO	ANCHO	PESO	TORNILLO
ASH-0605	4 Ø de 5/16" 2" X 2"	2"	2"	.090 KG	3/16"
ASH-0606	4 Ø de 3/8" 3" X 3"	3"	3"	.200 KG	3/16"
ASH-0607	4 Ø de 3/8" 4" X 4"	4"	4"	.370 KG	3/16"
ASH-0907	4 Ø de 1/2" 5" X 5"	5"	5"	.770 KG	1/4"
ASH-0608	4 Ø de 7/16" 6" X 6"	6"	6"	1.110 KG	1/4"
ASH-0609	4 Ø de 1/2" 8" X 8"	8"	8"	1.990 KG	1/4"
ASH-0701	4 Ø de 5/8" 10" X 10"	10"	10"	4.880 KG	3/8"
ASH-0702	4 Ø de 3/4" 12" X 12"	12"	12"	9.140 KG	1/2"



PLACA BASE SOLDABLE LIGERA

CODIGO	DESCRIPCION	LARGO	ANCHO	TORNILLO
ASH-1042	4 Ø de 1/2 (3/16" X 5" X 5")	5"	5"	3/16"
ASH-1043	4 Ø de 7/16 (3/16" X 6" X 6")	6"	6"	3/16"
ASH-1044	4 Ø de 1/2 (3/16" X 8" X 8")	8"	8"	3/16"
ASH-1045	4 Ø de 5/8 (1/4" X 10" X 10")	10"	10"	1/4"
ASH-1046	4 Ø de 3/4 (3/8" X 12" X 12")	12"	12"	3/8"



PERICO PARA VENTANA



CODIGO	DESCRIPCION
ASH-0075	A.S.H. (ACERO)
ASH-0076	CON DOBLEZ PARA VENTANA (ACERO)
ASH-0079*	ZAMAK

JALADERAS

CODIGO	DESCRIPCION	LARGO	ANCH O
ASH-0154	JALADERA TROQUELADA 2 AGUJEROS(GALVANIZADA)	4 3/4"	3 1/4"
ASH-0155	JALADERA TROQUELADA 4 AGUJEROS(GALVANIZADA)	6"	1 3/8"



MANIJA GALVANIZADA



CODIGO	DESCRIPCION	CAL.
ASH-0224	MANIJA TUBULAR CLASICA DERECHA	20
ASH-0225	MANIJA TUBULAR CLASICA IZQUIERDA	20
ASH-0222*	MANIJA PLANA DERECHA AZUL	12
ASH-0223*	MANIJA PLANA IZQUIERDA AZUL	12

PORTACHAPA NEGRO

CODIGO	DESCRIPCION	DIAMETRO	LARGO	ANCHO	CALIBRE
ASH-0509	PORTA CHAPA EMBUTIDO DOBLE 1" NEGRO	2 1/8"	7"	5 1/2"	1 "
ASH-0510	PORTA CHAPA EMBUTIDO SENCILLO 1" NEGRO	2 1/8"	4 1/4"	3 1/2"	1 "

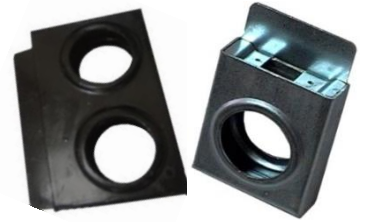

PORTACHAPA GALV.

CODIGO	DESCRIPCION	DIAMETRO	LARGO	ANCHO	CALIBRE
ASH-0611	PORTA CHAPA LISO DOBLE 1 1/4" NEGRO	2 1/8"	6 3/4"	5 1/2"	1 1/4"
ASH-0612	PORTA CHAPA LISO SENCILLO 1 1/4" NEGRO	2 1/8"	5 1/2"	3 1/2"	1 1/4"

RODILLO DE HULE

CODIGO	DESCRIPCION	DIAMETRO	LARGO
ASH-0610	RODILLO DE HULE LATERAL PARA PORTON 3" GALV. C/PERNOS	2.5"	3"
ASH-0724	RODILLO DE HULE LATERAL PARA PORTON 6" GALV. C/PERNOS	2.5"	6"
ASH-0886	RODILLO GUIA DE HULE ECONOMICO 3" NEGRO	2.5"	3"
ASH-0887	RODILLO GUIA DE HULE ECONOMICO 6" NEGRO	2.5"	6"



CLIP PARA POLIN

CODIGO	DESCRIPCION	U.V.	LARGO	ANCHO
ASH-0156	CLIP PARA POLIN 4" (0.44 KG) (0.750 LB)	KG	4"	2 1/4"
ASH-0159	CLIP PARA POLIN 5" (0.53 KG) (1.17 LB)	KG	5"	2 1/4"
ASH-0160	CLIP PARA POLIN 6" (0.61 KG) (1.30 LB)	KG	6"	2 1/4"
ASH-0162	CLIP PARA POLIN 8" (0.56 KG) (1.50 LB)	KG	8"	2 1/4"
ASH-0163	CLIP PARA POLIN 10" (0.92 KG) (2.10 LB)	KG	10"	2 1/4"



BALERO

CODIGO	DESCRIPCION
ASH-0009	BALERO 350 VENTANA RADIAL GALVANIZADO



BISAGRA DE PROYECCION

CODIGO	DESCRIPCION
ASH-0042	BISAGRA DE PROYECCION C-10 CAL 10



MECANISMO GALVANIZADO

CODIGO	DESCRIPCION	PESO
ASH-0282	MECANISMO GALVANIZADO 4" (102 X 128MM.)	.790 KG
ASH-0280	MECANISMO GALVANIZADO 6" (145 X 162MM.)	1.080 KG



ABASTECEDORA DE SOLDADURA Y HERRAJES S.A. DE C.V.

MIER Y NORIEGA No. 304 NTE. C.P. 67100 CD. GUADALUPE, N.L. MEXICO

Conmutador: (81) 83-54-83-45 Fax: (81) 83-54-83-45

admonventas@ashmex.com www.ashmex.com

ASH IMPORT & EXPORT LLC

601-E CEDAR AVE, SUITE E MC ALLEN, TX 78501 USA

PHONE/FAX : (956) 8004448 CELL PHONE: (956) 3880948

ashiellc@hotmail.com ashimportexport@gmail.com www.ashmex.com

ESFERA TROQUELADA

CODIGO	DESCRIPCION	DIAMETRO
ASH-0450	ESFERA TROQUELADA (25MM.) 1" ENTRADA SENCILLA	1"
ASH-0451	ESFERA TROQUELADA (38MM.) 1 1/2" DOBLE ENTRADA	1 1/2"
ASH-0452	ESFERA TROQUELADA (38MM.) 1 1/2" ENTRADA SENCILLA	1 1/2"
ASH-0453	ESFERA TROQUELADA (51MM.) 2" DOBLE ENTRADA	2"
ASH-0454	ESFERA TROQUELADA (51MM.) 2" ENTRADA SENCILLA	2"



BISAGRA DE LIBRO CIEGA

CODIGO	DESCRIPCION	LARGO	ANCHO
ASH-0673	2X2 GRUESA CAL. 14	2"	2"
ASH-0690	2 1/4 X 3 1/2 CAL. 14	3.5"	2 1/4"
ASH-0674	3X3 GRUESA CAL. 13	3"	3"
ASH-0675	3.5 X 3.5 GRUESA CAL. 13	3.5"	3.5"
ASH-0676	4X4 GRUESA CAL. 12	4"	4"



RESORTE GALVANIZADO

CODIGO	DESCRIPCION	LARGO
ASHD-0277	RESORTE PARA PUERTA MOSQUITERA GALV.	16 1/4"



MORDAZA PARA PTR

CODIGO	DESCRIPCION
ASH-0660	MORDAZA PARA PTR EN ACERO GALV. 3/8 X 1/4"
ASH-0661	MORDAZA PARA PTR EN ACERO GALV. 3/8 X 3/8"

SUJETA RIEL

CODIGO	DESCRIPCION
ASH-0286	SUJETA RIEL PARA RIEL PESADO (1500 - 9000)

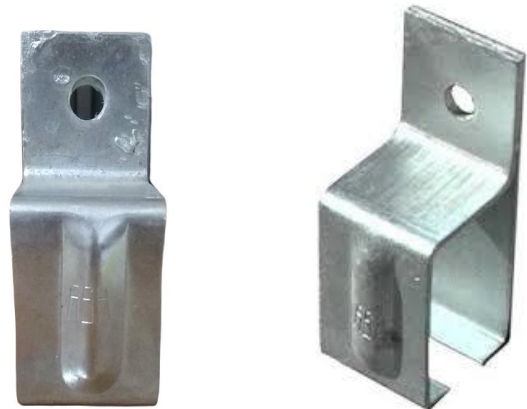

TROLES ASH

TROLE TIPO JALON ASH COLOR VERDE.

CODIGO	DESCRIPCION
ASH-0548X	TROLE TIPO JALON ASH 250KG. RUEDA REFORZADA (VERDE)
ASH-0549X	TROLE TIPO JALON ASH 500KG. RUEDA REFORZADA (VERDE)
ASH-0550X	TROLE TIPO JALON ASH 1000KG. RUEDA REFORZADA (VERDE)

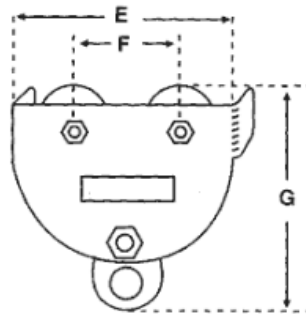
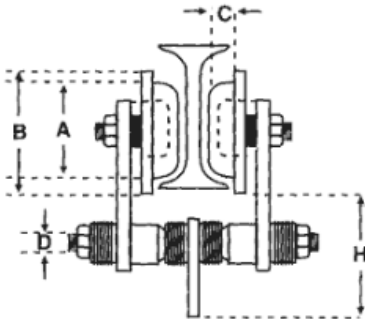

Modelo	CAP. TONS.	PESO LBS. KGS.	PERALTE VIGA	ANCHO PATIN	RADIO GIRO	A	B	C	D	E	F	G	H	MEDIDA EN
P-250	.25	5	3" - 9"	1.8" - 4"	36"	1.900"	2.675"	.63"	.750"	8.110"	3.750"	4.75"	4.5"	PULG.
			76 - 228	45 - 101	914	48.26	68	16	19	206	95	120	114	MM.
P-500	.500	8	3" - 15"	2.5" - 5.3"	39"	2.175"	3.050"	.825"	.875"	8.620"	5.150"	5.150"	6.250"	PULG.
			76 - 381	63 - 135	990	55.24	77	20.95	22	219	130	130	158	MM.
P-1000	1	12	5" - 24"	3" - 8"	49"	3.175"	4"	1.250"	1.0"	11.330"	5.980"	11.250"	7.280"	PULG.
			127 - 609	76 - 203	124	80.64	101	31.75	25.4	288	152	285	185	MM.

- Las placas laterales son de acero.
- Las ruedas son de fundición gris maquinadas.
- Cada rueda lleva un balero sellado.
- Chumacera soldadas de tubo mecánico para mayor estabilidad.
- El eje principal lleva rondanas de ajuste para diferentes anchos de patín.
- Oreja de acero para insertar el gancho del polipasto.
- Las placas son dobladas en cada extremo y sirven como guardas para protección del trole.
- Estos troles se usan en vigas IPS ó IPR.

Hecho en México

TROLES ASH

TROLE ECONOMICO ASH COLOR AZUL.

CODIGO	DESCRIPCION
ASH-0901	TROLE ECONOMICO ASH 250KG. RUEDA MAQUINADA (AZUL)
ASH-0902	TROLE ECONOMICO ASH 500KG. RUEDA MAQUINADA (AZUL)
ASH-0903	TROLE ECONOMICO ASH 1000KG. RUEDA MAQUINADA (AZUL)

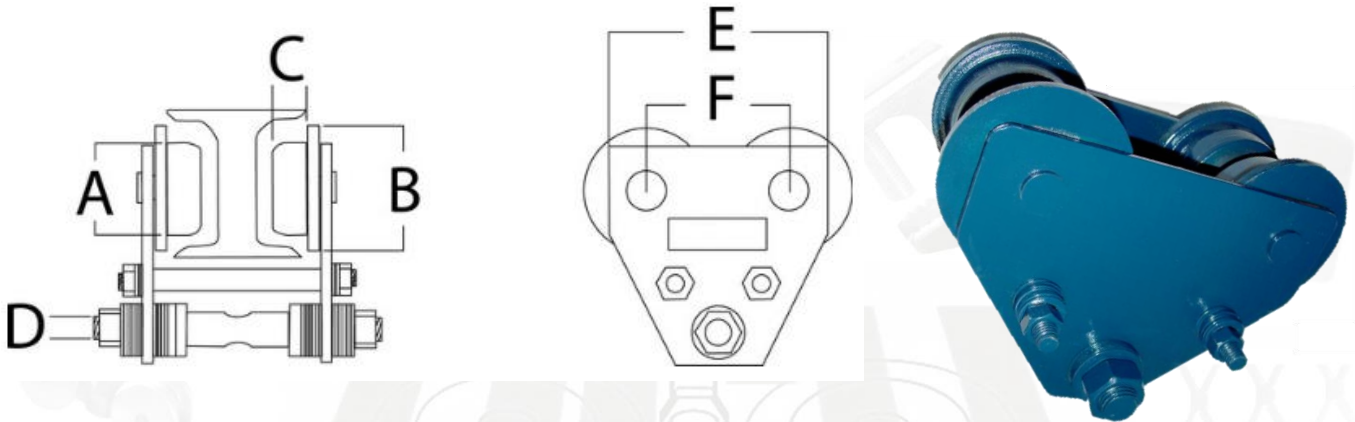

MODELO	CAP.	PESO KGS	ANCHO PATIN	PERALTE VIGA	A	B	C	D	E	F
ECOMET 250	¼ TON	4	2.2" - 3"	3" - 8"	2.185"	3.062"	0.820"	0.750"	7.250"	4.1875"
ECOMET 500	½ TON	4.3	2.2" - 3"	3" - 8"	2.185"	3.062"	0.820"	0.750"	7.250"	4.1875"
ECOMET 1000	1 TON	8	2.875" - 4.025"	4" - 9"	3.180"	4"	1.145"	0.875"	10"	6.125"

- Placas laterales de acero
- Ruedas de fundición gris maquinadas
- Un balero sellado en cada rueda
- Un eje principal, más dos refuerzos de acero con rondanas de ajuste.
- Útil tanto en viga IPS como IPR

Hecho en México

CORREDERAS DE 4 RUEDAS PARA RIEL 1500

CODIGO	DESCRIPCION	DIAMETRO	LARGO	ANCHO	CAPACIDAD X PAR
ASH-0668*	9001 RUEDAS Y CUERPO TROQUELADOS EN LAM. CAL. 14	2"	4 3/4"	1 1/2"	150 KG
ASH-0669*	9051 RUEDA MAQUINADA CON BALERO Y CUERPO TROQ. EN LAM. CAL.14	2"	5"	1 1/2"	180 KG
ASH-0099*	9100 RUEDA MAQUINADA SOLIDA Y CUERPO DE SOLERA 1 1/4" x 3/4"	2"	5"	1 1/2"	150 KG
ASH-0210	9120 RUEDA TROQUELADAS LAM. CAL. 14 CUERPO CUAD. 3/4"	2"		1 1/2"	
ASH-0412*	9140 RUEDA MAQUINADA CON BALERO Y CUERPO CUADRADO DE 3/4"	2"	4 3/4"	1 1/2"	200 KG
ASH-0100*	9150 RUEDA MAQUINADA CON BALERO Y CUERPO DE SOLERA 1 1/4" x 3/4"	2"	5"	1 1/2"	200 KG



9001

Corredera de Cuerpo & Ruedas Troquelados en Lamina Cal. 14



9051

Corredera de Cuerpo Troquelado en Lamina Cal. 14 Ruedas Maquinadas C/Balero & Perno de 3/4"



9120

Corredera de Cuerpo cuadrado de 3/4" & Ruedas Troqueladas en Lamina Cal. 14



9140

Corredera de Cuerpo Cuadrado de 3/4" Ruedas Maquinadas C/Balero & Perno de 3/4"



9100

Corredera de Cuerpo en Solera de 1 1/4" x 3/4" Ruedas Maquinadas Solidas c/ Perno de 1/2" & Buje de Bronce.



9150

Corredera de Cuerpo en Solera de 1 1/4" x 3/4" Ruedas Maquinadas C/Balero & Perno de 3/4"

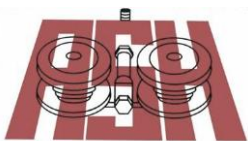

CORREDERA PARA RIEL 1500 DE 4 RUEDAS MODELO 9001

Carrucha 9001 Completamente Mejorada

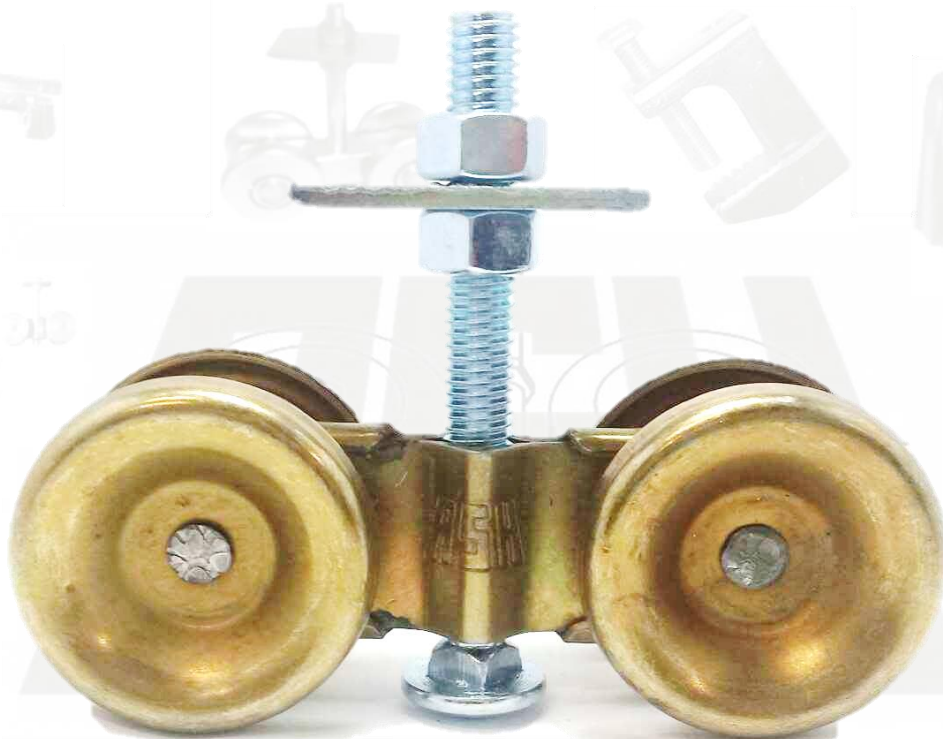

- * *Su cuerpo es Troquelado Laminado en Cal. 14".*
- * *Cuerpo Engargolado*
- * *Buje de acero maquinado, pernos en acero de alta resistencia*
- * *Acabado Tropicalizado.*
- * *Mayor Resistencia a la corrosion.*
- * *Ruedas Troqueladas Lamina en Cal. 14"*
- * *Con función de sujeta tornillo para una mejor instalación.*

www.ashmex.com

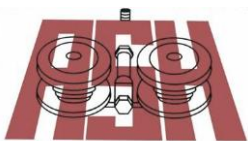

CORREDERA PARA RIEL 1500 DE 4 RUEDAS MODELO 9051

Carrucha 9051 Completamente Mejorada



- * *Su Cuerpo es Troquelado Laminado en Cal. 14".*
- * *Cuerpo Engargolado*
- * *Acabado Tropicalizado.*
- * *Mayor Resistencia a la corrosion.*
- * *Eje de mayor diámetro lo que permite una mayor capacidad de carga*
- * *Ruedas Maquinadas C/Balero & Perno de 3/4 "*
- * *Con función de sujeta tornillo para una mejor instalación.*

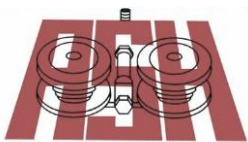

CORREDERA PARA RIEL 1500 DE 4 RUEDAS MODELO 9120

Carrucha 9120 Cuerpo Cuadrado 3/4 "



*Cuerpo cuadrado de 3/4 "

*Ruedas Troqueladas en Lamina Cal. 14

*Buje de acero maquinado, pernos en acero de alta resistencia.

* Acabado Tropicalizado.

* Mayor Resistencia a la corrosion.

*Con función de sujeta tornillo para una mejor instalación.

www.ashmex.com

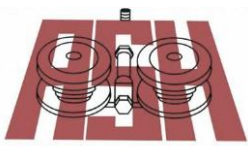

CORREDERA PARA RIEL 1500 DE 4 RUEDAS MODELO 9140

Carrucha 9140 Cuerpo Cuadrado de $\frac{3}{4}$ "



*Cuerpo Cuadrado de $\frac{3}{4}$ "

*Ruedas Maquinadas C/Balero &

*Perno de $\frac{3}{4}$ " de alta resistencia.

* Acabado Tropicalizado.

* Mayor Resistencia a la corrosión.

**Con función de sujeta tornillo para una mejor instalación.*

www.ashmex.com

ABASTECEDORA DE SOLDADURA Y HERRAJES S.A. DE C.V.

MIER Y NORIEGA No. 304 NTE. C.P. 67100 CD. GUADALUPE, N.L. MEXICO

Conmutador: (81) 83-54-83-45 Fax: (81) 83-54-83-45

admonventas@ashmex.com www.ashmex.com

ASH IMPORT & EXPORT LLC

601-E CEDAR AVE, SUITE E MC ALLEN, TX 78501 USA

PHONE/FAX : (956) 8004448 CELL PHONE: (956) 3880948

ashiellc@hotmail.com ashimportexport@gmail.com www.ashmex.com

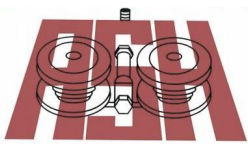

CORREDERA PARA RIEL 1500 DE 4 RUEDAS MODELO 9100

Carrucha 9100 Cuerpo Solera 1 1/4" x 3/4"



*Cuerpo en Solera de 1 1/4" x 3/4"

*Ruedas Maquinadas Solidas
c/ Perno de 1/2"
& Buje de Bronce.

* *Acabado Tropicalizado.*

* *Mayor Resistencia a la corrosion.*

* *Con función de sujeta tornillo para una mejor instalación.*

www.ashmex.com

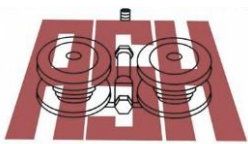

CORREDERA PARA RIEL 1500 DE 4 RUEDAS MODELO 9150

Carrucha 9150 Cuerpo en Solera 1 1/4" x 3/4"

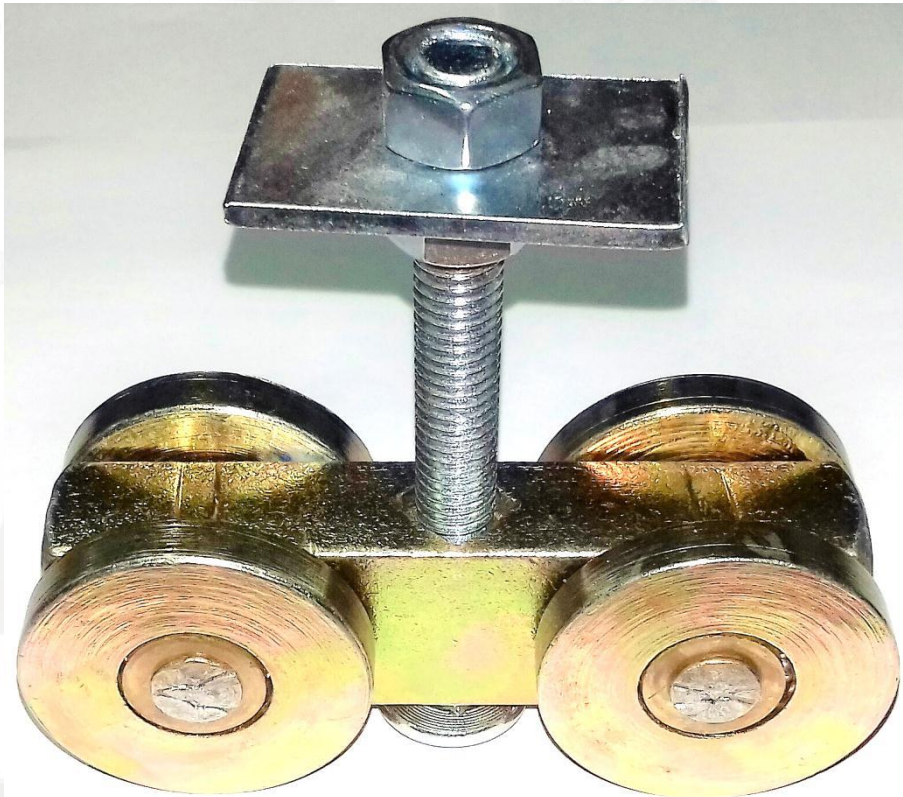

*Cuerpo en Solera de 1 1/4 " x 3/4 "

*Ruedas Maquinadas solidas

*C/Balero & Perno de 3/4 "

* *Acabado Tropicalizado.*

* *Mayor Resistencia a la corrosion.*

* *Con función de sujeta tornillo para una mejor instalación.*

www.ashmex.com

CORREDERAS DE 4 RUEDAS PARA RIEL 1400

CODIGO	DESCRIPCION	DIAMETRO	LARGO	ANCHO	CAPACIDAD X PAR
ASH-0095*	8001 RUEDAS Y CUERPO TROQUELADO EN LAMINA CAL. 14 ECONOMICA	1"	2 1/2"	1 1/2"	60 KG
ASH-0197*	8051 RUEDAS SOLIDAS DE 1" C/BALEROS & CUERPO TROQUELADO	1"	2 1/2"	1 1/2"	75 KG
ASH-0150*	8151 RUEDAS SOLIDAS DE 1" C/BALEROS & CUERPO REFORZADO EN CUAD. DE 5/8"	1"	3"	1 1/2"	100 KG



8001

Corredera de
Cuerpo & Ruedas
Troqueladas en
Lamina Cal. 14



8051

Corredera de
Cuerpo Troquelado
Ruedas de 1"
C/Balero.



8151

Corredera de
Cuerpo Reforzado
Cuadrado de 5/8"
Ruedas de 1"
C/Balero.

Maq. =Maquinada

Troq. =Troquelada

Lam. = Lamina

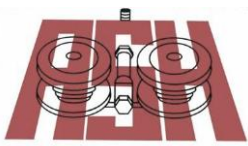

CORREDERA PARA RIEL 1400 DE 4 RUEDAS MODELO 8001

Carrucha 8001



- * *Su cuerpo es Troquelado Laminado en Cal. 14".*
- * *Acabado Tropicalizado.*
- * *Mayor Resistencia a la corrosion.*
- * *Rueda Troquelada y Remachada.*
- * *Con función de sujeta tornillo para una mejor instalación.*



www.ashmex.com

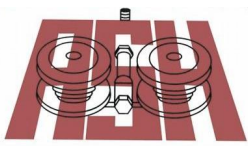

CORREDERA PARA RIEL 1400 DE 4 RUEDAS MODELO 8051

Carrucha 8051



- * Su cuerpo es Troquelado Laminado en Cal. 14".
- * Acabado Tropicalizado.
- * Mayor Resistencia a la corrosion.
- * Función de un rodamiento tipo automotriz ya que esta elaborada
- * con posta de 1/8 entre las ruedas y el eje reforzado
 - * Rueda con guía maquinada en acero de 1"
- * Con función de sujeta tornillo para una mejor instalación.



www.ashmex.com

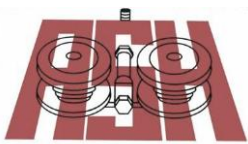

CORREDERA PARA RIEL 1400 DE 4 RUEDAS MODELO 8151

Carrucha 8151



- * *Cuerpo solido y cuadrado 5/8*
- * *Acabado Tropicalizado.*
- * *Mayor Resistencia a la corrosion.*
- * *Con función de sujeta tornillo para una mejor instalaci3n.*
- * Ruedas con postas para mejor deslizamiento y mayor carga



www.ashmex.com

RUEDAS MAQUINADAS PARA ANGULO 90°

CODIGO	DESCRIPCION	DIAMETRO	ANCHO	CAPACIDAD X PAR
RUEDA CON CAJA				
ASH-0516	2" X 5/8" C/ BALERO REFORZADA.	2"	5/8"	100 KG.
ASH-0530	2-1/2" X 3/4" C/ BALERO REFORZADA.	2 1/2"	3/4"	150 KG.
ASH-0517	3" X 3/4" C/ BALERO REFORZADA.	3"	3/4"	200 KG.
ASH-0620	3" X 1 1/2" C/ BALERO REF. TRABAJO PESADO	3"	1 1/2"	400 KG.
ASH-0892	4" X 1 3/4" C/BALERO REFORZADA.	4"	1 3/4"	

RUEDAS SIN CAJA				
ASH-0428	2" X 5/8" CON BALERO REFORZADA	2"	5/8"	100 KG.
ASH-0543	2-1/2" X 3/4" CON BALERO REFORZADA	2 1/2"	3/4"	150 KG.
ASH-0495	3" X 3/4" CON BALERO REFORZADA.	3"	3/4"	200 KG.
ASH-0625	3" X 1 1/2" C/BALERO REF. TRABAJO PESADO	3"	1 1/2"	400 KG.
ASH-0891	4" X 1 3/4" C/BALERO REFORZADA.	4"	1 3/4"	



RUEDAS MAQUINADAS EN RADIO PARA REDONDOS

CODIGO	DESCRIPCION	DIAMETRO	ANCHO	CAPACIDAD X PAR
--------	-------------	----------	-------	-----------------

RUEDA CON CAJA				
ASH-0715	2"X 5/8" C/BAL.REF.TROP.	2"	5/8"	100 KG.
ASH-0717	2-1/2"X3/4" C/BAL.REF.	2 1/2"	3/4"	150 KG.
ASH-0716	3"X 3/4"C/BAL.REF.	3"	3/4"	200 KG.
ASH-0718	3"X1 1/2" TRABAJO PESADP	3"	1 1/2"	400 KG.

RUEDAS SIN CAJA				
ASH-0720	2"X 5/8" C/BALERO REF.	2"	5/8"	100 KG.
ASH-0722	2-1/2"X3/4" C/BALERO REF.	2 1/2"	3/4"	150 KG.
ASH-0721	3"X 3/4"C/BALERO REF.	3"	3/4"	200 KG.
ASH-0719	3"X1 1/2" TRABAJO PESADO	3"	1 1/2"	400 KG.



RUEDAS DE FIERRO VACIADO

CODIGO	DESCRIPCION	DIAMETRO	GROSOR	CAPACIDAD
RUEDA SIN CAJA				
ASH-0502	4" DOBLE BALERO	4"	1 3/4"	150 lb.
ASH-0503	4" "CON CAJA" DOBLE BALERO	4"	1 3/4"	150 lb.
ASH-0504	6" DOBLE BALERO	6"	2 1/2"	200 lb.
ASH-0505	6" "CON CAJA" DOBLE BALERO	6"	2 1/2"	200 lb.

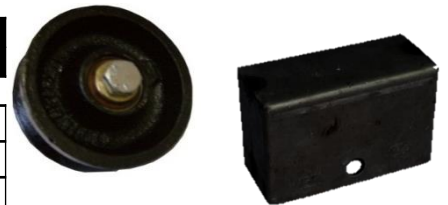

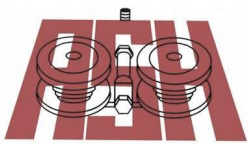

RUEDAS MAQUINADAS PARA ANGULO 90°

& EN RADIO PARA REDONDOS.

**Rueda de acero maquinado en acero 1018 perno exacto con las medida exacta del balero evitando uso de bujes acabado tropicalizado. Caja troquelada de una sola pieza evitando el uso múltiple de soldaduras en Cal. 12*

MEDIDAS:

2 X 3/4" : carga por par 100 kg

2 1/2 X 3/4" : carga por par 150 kg

3" X 3/4" : carga por par 200 kg

3" X 1 1/2" (Trabajo Pesado) : carga por par 400 kg



RUEDAS DE FIERRO VACIADO

**Reforzada con doble balero automotriz, perno con la medida exacta del interior de los baleros permitiendo con esto mayor ajuste y evitando el uso de bujes. Caja troquelada de una sola pieza evitando el uso múltiple de soldaduras*

MEDIDAS:

Rueda de 4" : carga por par 500 kg

Rueda de 6" : carga por par 600 kg



ARO DE PERFIL TUBULAR CUAD. 1/2" CAL 16

CODIGO	DESCRIPCION	DIAMETRO	LARGO	ANCHO
ASFC-0620	ARO 4 "	4"	4"	4"
ASFC-0621	ARO 4 1/2"	4 1/2"	4 1/2"	4 1/2"
ASFC-0622	ARO 5 "	5"	5"	5"



BIBEL PIVOTE

ASH-0508	BIBEL PIVOTE 5/8" (6" X 1 1/2" X 1/4") CHICO CON BALERO
ASH-0506	BIBEL PIVOTE 5/8" (7" X 2" X 1/4") MEDIANO CON BALERO
ASH-0507	BIBEL PIVOTE 3/4" (8" X 2 1/2" X 1/4") GRANDE CON BALERO
ASH-0565	BIBEL PIVOTE 1/2" (6" X 1 1/2" X 3/16") ACABADO NATURAL
ASH-0768	BIBEL PIVOTE 1/2" (6" X 1" X 1/4") ACABADO NATURAL
ASH-0770	BIBEL PIVOTE 1/2" (7" X 1" X 1/4") ACABADO NATURAL
ASH-0769	BIBEL PIVOTE 5/8" (6" X 1 1/2" X 3/16") ACABADO NATURAL
ASH-0767	BIBEL PIVOTE 5/8" (7" X 1 1/2" X 1/4") ACABADO NATURAL
ASH-0771	BIBEL PIVOTE 5/8" (7" X 1 1/4" X 1/4") ACABADO NATURAL
ASH-0566	BIBEL PIVOTE 5/8" (6" X 2" X 1/4") GRANDE SIN BALERO
ASH-0164	BIBEL PIVOTE 5/8" (7" X 2" X 1/4") ASH INFERIOR
ASH-0165	BIBEL PIVOTE 5/8" (7" X 2" X 1/4") ASH SUPERIOR



RIEL EN ANGULO ESPECIAL PARA RUEDAS DE 2", 2

1/2", 3", 4" Y 6"

- * En acero galvanizado Cal. 10
- * Fabricada en una sola pieza.
- * Largo de 10 FT
- * Con agujeros de 1/4"

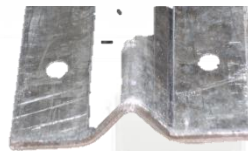

CODIGO	DESCRIPCION	LARGO	PESO
ASH-0704	RIEL GUIA EN ANGULO	10 FT	6.00 KG

ANILLO PARA LANZA PTR DECORATIVA



CODIGO	DESCRIPCION
ASH-0733	ANILLO PARA PTR 1/2"



MECANISMO PARA PUERTA CORREDIZA

CODIGO	DESCRIPCION	LARGO	ANCHO
ASH-0667	MECANISMO SIN RUEDA	12 1/2"	3 3/4"
ASH-0707	MECANISMO CON RUEDA GIRATORIA 3"	17"	3 3/4"

ABASTECEDORA DE SOLDADURA Y HERRAJES S.A. DE C.V.

MIER Y NORIEGA No. 304 NTE. C.P. 67100 CD. GUADALUPE, N.L. MEXICO

Conmutador: (81) 83-54-83-45 Fax: (81) 83-54-83-45

admonventas@ashmex.com www.ashmex.com

ASH IMPORT & EXPORT LLC

601-E CEDAR AVE, SUITE E MC ALLEN, TX 78501 USA

PHONE/FAX : (956) 8004448 CELL PHONE: (956) 3880948

ashiellc@hotmail.com ashimportexport@gmail.com www.ashmex.com

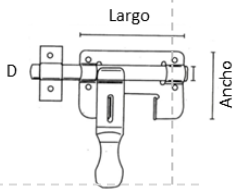

PASADORES

PASADOR OREJON No. 3

CODIGO	DESCRIPCION	ACABADO	CAL. LAMINA
ASH-0708	PASADOR OREJON No. 3 REF. Ø 1/2"	NATURAL	12



PASADOR AMBIDIESTRO RUSTICO

CODIGO	DESCRIPCION	ACABADO	CAL. LAMINA	D	LARGO	ANCHO
ASH-0240	RUSTICO No.4 REF. Ø 5/8"	Negro	11	5/8"	4"	3"
ASH-0241	RUSTICO No.5 REF. Ø 5/8"	Negro	11	5/8"	5"	3"
ASH-0242	RUSTICO No.6 REF. Ø 5/8"	Negro	11	5/8"	6"	3"
ASH-0202X	RUSTICO NEG. No.5X EXTRA REF. Ø 3/4" C	Negro	11	3/4"		
ASH-0203X	RUSTICO NEG. No.6X EXTRA REF. Ø 3/4" C	Negro	11	3/4"		

PASADOR AMBIDIESTRO CLASICO

CODIGO	DESCRIPCION	ACABADO	CAL. LAMINA	D	LARGO	ANCHO	PESO
ASH-0257	CLASICO No.3 PESADO Ø 3/8"	Galvanizado	14	3/8"	3 1/2"	4 1/4"	0.150 KG
ASH-0258	CLASICO No.4 PESADO Ø 1/2"	Galvanizado	12	1/2"	4"	4 3/4"	0.260 KG
ASH-0259	CLASICO No.5 PESADO Ø 5/8"	Galvanizado	12	5/8"	5"	5 1/4"	0.480 KG
ASH-0260	CLASICO No.6 PESADO Ø 5/8"	Galvanizado	12	5/8"	6"	5 3/4"	0.551 KG
ASH-0651	CLASICO No.7 PESADO Ø 3/4"	Galvanizado	11	3/4"	11"	6"	



PASADOR AMBIDIESTRO COLONIAL



CODIGO	DESCRIPCION	ACABADO	CAL. LAMINA	D	LARGO	ANCHO
ASH-0523	COLONIAL No.4 REF. Ø 5/8"	Negro	11	5/8"	6"	5"
ASH-0524	COLONIAL No.6 REF. Ø 3/4"	Negro	11	3/4"	8 1/2"	5"
ASH-0525	COLONIAL No.7 REF. Ø 3/4"	Negro	11	3/4"	10"	5 1/2"
ASH-0569	COLONIAL No.9 Extra REF Ø1"	Negro	11	1"	13"	8"
ASH-0526	COLONIAL No.4 REF. Ø 5/8"	Galvanizado	11	5/8"	6"	5"
ASH-0527	COLONIAL No.6 REF. Ø 3/4"	Galvanizado	11	3/4"	8 1/2"	5"
ASH-0528	COLONIAL No.7 REF. Ø 3/4"	Galvanizado	11	1"	13"	8"

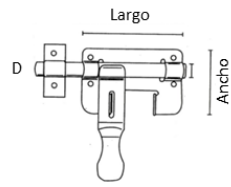
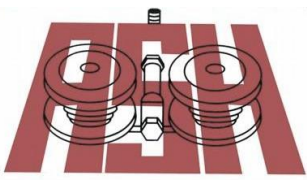

PASADOR No. 3



PASADOR No. 3 «OREJON»

***Barra en redondo de 1/2"**

***Cuerpo mas grueso en calibre 12**

***Troquelado en una sola pieza**

***Menos soldadura = Una mejor**

presentación

www.ashmex.com

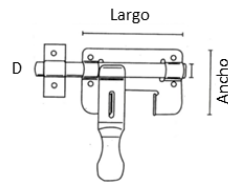
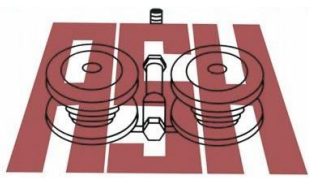

PASADOR AMB. RUSTICO



Medidas 4" 5" & 6"

***Barra en redondo de 5/8"**

***Cuerpo mas grueso en calibre 11**

***Troquelado en una sola pieza**

***Menos soldadura = Una mejor presentación**

Medidas 5x" & 6x"

***Barra en redondo de 3/4"**

***Cuerpo mas grueso en calibre 11**

***Troquelado en una sola pieza**

***Menos soldadura = Una mejor presentación**

www.ashmex.com

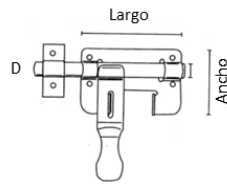
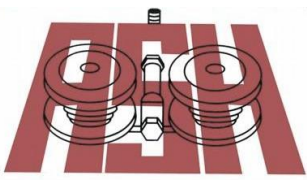

PASADOR AMB. GALVANIZADO

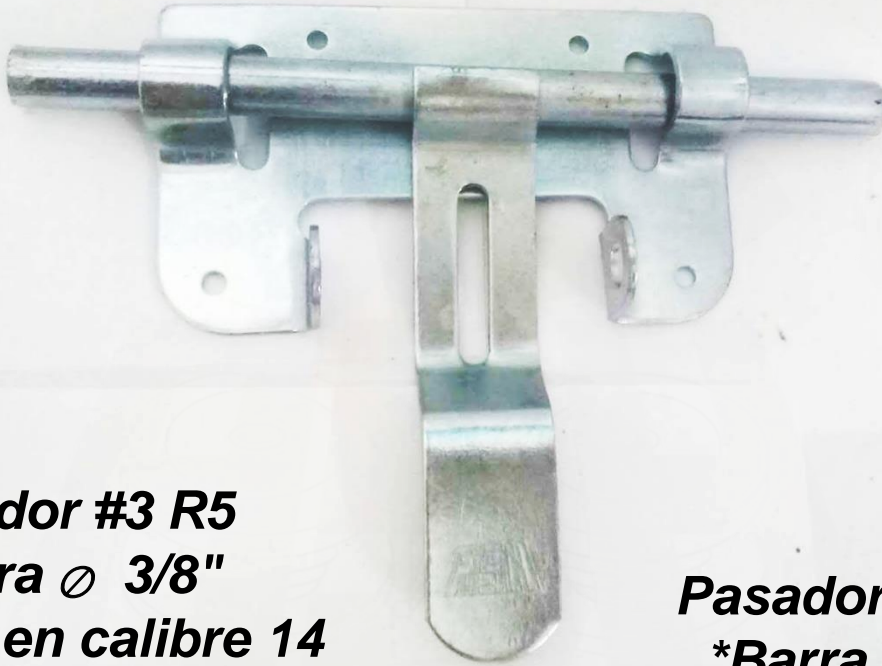

Pasador #3 R5

***Barra \varnothing 3/8"**

***Cuerpo en calibre 14**

Pasador #4 R10

***Barra \varnothing 1/2"**

***Cuerpo en calibre 12**

Pasador #5 R15

***Barra \varnothing 5/8"**

***Cuerpo en calibre 12**

Pasador #6 R25

***Barra \varnothing 5/8"**

***Cuerpo en calibre 12**

Pasador #7 R35

***Barra \varnothing 3/4"**

***Cuerpo en calibre 11**

***Troquelado en una sola
pieza**

***Menos soldadura = Una
mejor presentación**

www.ashmex.com

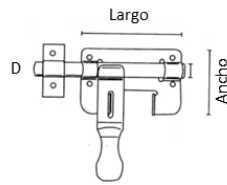
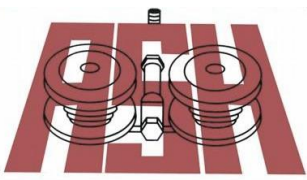

PASADOR AMB. COLONIAL NEGRO

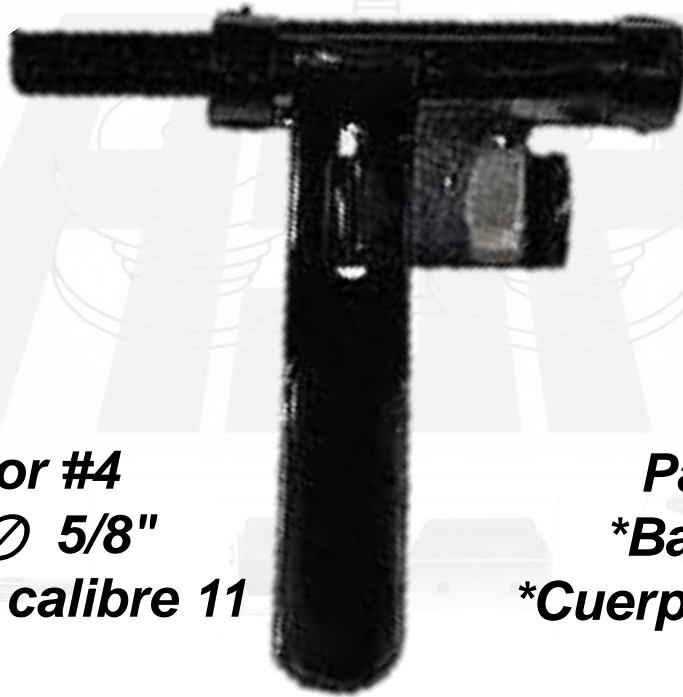

Pasador #4

***Barra \varnothing 5/8"**

***Cuerpo en calibre 11**

Pasador #7

***Barra \varnothing 3/4"**

***Cuerpo en calibre 11**

Pasador #6

***Barra \varnothing 3/4"**

***Cuerpo en calibre 11**

Pasador #9

***Barra \varnothing 1"**

***Cuerpo en calibre 11**

***Troquelado en una sola pieza**

***Menos soldadura = Una mejor
presentación**

www.ashmex.com

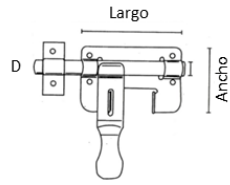
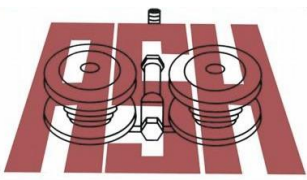

PASADOR AMB. COLONIAL GALVANIZADO



Pasador #4

***Barra \varnothing 5/8"**

***Cuerpo en calibre
11**

Pasador #6

***Barra \varnothing 3/4"**

***Cuerpo en calibre 11**

Pasador #7

***Barra \varnothing 3/4"**

***Cuerpo en calibre 11**

***Troquelado en una sola pieza**

***Menos soldadura = Una mejor
presentación**

www.ashmex.com

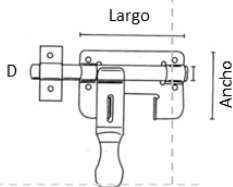

PASADORES

PASADOR AMBIDIESTRO GIGANTE DE TUBO



CODIGO	DESCRIPCION	ACABADO	CAL.		
			LAMINA	LARGO	ANCHO
ASH-0232	PASADOR NATURAL CAL. 11 CED.40	NATURAL	13	14 1/2"	1 1/2"
ASH-0212	PASADOR GALV. 15R 1 5/16" CED 40	GALV	10	15"	1 1/2"

PASADOR PORTACANDADO



CODIGO	DESCRIPCION	ACABADO	CAL.		
			LAMINA	LARGO	ANCHO
ASH-0254	PORTACANDADO No. 2	Galvanizado	14	2 3/4"	1 1/2"
ASH-0255	PORTACANDADO No. 4	Galvanizado	14	4"	2"
ASH-0256	PORTACANDADO No. 6	Galvanizado	14	6"	2"

PASADOR CERROJO

CODIGO	DESCRIPCION	ACABADO	CAL.			
			LAMINA	LARGO	ANCHO	PESO
ASH-0244	CERROJO (80-30) 1 1/4"	Galv.	18	1 1/4 "	1 1/4 "	0.035 KG
ASH-0243	CERROJO (80-40) 1 1/2"	Galv.	18	1 1/2"	1 1/2 "	0.050 KG
ASH-0245	CERROJO (80-50) 2 "	Galv.	18	2 "	2 "	0.070 KG
ASH-0246	CERROJO (80-60) 2 1/2"	Galv.	18	2 1/2"	2 1/2"	0.070 KG
ASH-0247	CERROJO (80-75) 3"	Galv.	18	3 "	3 "	0.080 KG
ASH-0248	CERROJO (80-102) 4"	Galv.	18	4"	4 "	



PASADOR DE SEGURIDAD

CODIGO	DESCRIPCION	ACABADO	CAL.			
			LAMINA	LARGO	ANCHO	PESO
ASH-0262	PASADOR DE SEGURIDAD No. 2	Tropicalizado	16	2"	1 1/2"	0.050 KG
ASH-0263X	PASADOR DE SEGURIDAD No. 4	Tropicalizado	16	3 1/2 "	1 1/2"	0.080 KG

PASADOR MULTIUSOS

CODIGO	DESCRIPCION	ACABADO	CAL.			
			LAMINA	LARGO	ANCHO	PESO
ASH-0173	MULTIUSOS No. 4 CUAD.1/2	Tropicalizado	13	6"	2"	0.330 KG
ASH-0187	MULTIUSOS No. 5 CUAD.5/8	Tropicalizado	13	8"	2"	0.610 KG



PASADORES DE PISO

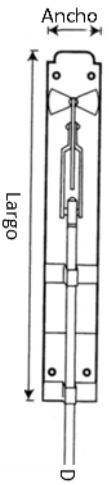

PASADOR DE PISO CUADRADO

CODIGO	DESCRIPCION	ACABADO	CAL. LAMINA
ASH-0234*	CUADRADO No. 9 (A20) 1/2"	Galvanizado	12
ASH-0236*	CUADRADO No.12 (A30) 1/2"	Galvanizado	12
ASH-0238*	CUADRADO No.16 (A40) 1/2"	Galvanizado	12
ASH-0479*	CUADRADO No.18 (A50) 1/2"	Galvanizado	12
ASH-0239*	CUADRADO No.22 (A60) 1/2"	Galvanizado	12



PASADOR DE PISO REDONDO

CODIGO	DESCRIPCION	ACABADO	CAL. LAMINA
ASH-0341*	REDONDO No. 9 (A20) ϕ 1/2"	Galvanizado	12
ASH-0342*	REDONDO No.12 (A30) ϕ 5/8"	Galvanizado	12
ASH-0343*	REDONDO No.16 (A40) ϕ 5/8"	Galvanizado	12
ASH-0344*	REDONDO No.22 (A60) ϕ 5/8"	Galvanizado	12



PASADOR DE PISO RUSTICO



CODIGO	DESCRIPCION	ACABADO	CAL.				
			LAMINA	D	LARGO	ANCHO	
ASH-0250	RUSTICO No. 9 (A20)	Negro	10	5/8"	9"	1 1/4"	
ASH-0251	RUSTICO No. 12 (A30)	Negro	10	5/8"	12"	1 1/4"	
ASH-0252	RUSTICO No. 16 (A40)	Negro	10	5/8"	16"	1 1/4"	
ASH-0480	RUSTICO No. 18 (A50)	Negro	10	5/8"	18"	1 1/4"	
ASH-0253	RUSTICO No. 22 (A60)	Negro	10	5/8"	22"	1 1/4"	

PASADOR DE PISO DE BOLA



CODIGO	DESCRIPCION	ACABADO	CAL.			
			LAMINA	BARRA	LARGO	ANCHO
ASH-0166	BOLA DOBLE No. 9	Negro	10	\square 1/2"	9"	2 3/4"
ASH-0167	BOLA DOBLE No. 12	Negro	10	\square 1/2"	12"	0 3/4"
ASH-0168	BOLA DOBLE No. 16	Negro	10	\square 1/2"	16"	1 3/4"
ASH-0169	BOLA DOBLE No. 22	Negro	10	\square 1/2"	22"	1 3/4"

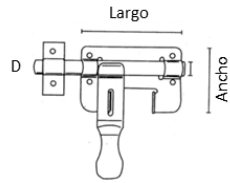
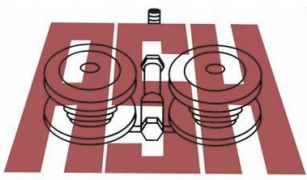

PASADOR DE PISO GALVANIZADO CUADRADO & REDONDO



Cuadrado Medidas

9" 12" 16" 18" & 22"

****Barra en cuadrado de 1/2"***

****Cuerpo mas grueso en calibre 12***

****Troquelado en una sola pieza***

****Menos soldadura = Una mejor
presentación***

www.ashmex.com

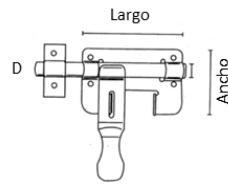
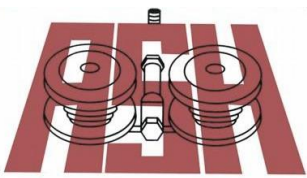

PASADOR DE PISO NEGRO RUSTICO



Rustico Medidas

9" 12" 16" 18" & 22"

**Barra en redondo de 5/8"*

**Cuerpo mas grueso en calibre 10*

**Menos soldadura = Una mejor
presentación*

www.ashmex.com

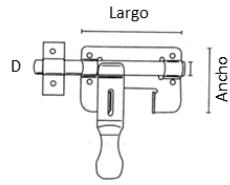
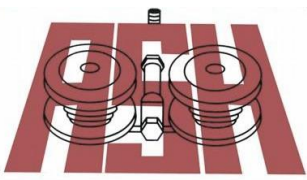

PASADOR DE PISO NEGRO DE BOLA



*De Bola Medidas
9" 12" 16" & 22"*

**Barra en cuadrado de 1/2"*

**Cuerpo mas grueso en calibre 10*

**Menos soldadura = Una mejor presentación*

www.ashmex.com

CHAPETONES & CANASTAS

CODIGO	DESCRIPCION	LARGO	ANCHO	PESO
ASHT-0125	ALA DE ANGEL DERECHA NEGRO	4 3/8"	1 5/8"	0.209 KG
ASHT-0126	ALA DE ANGEL IZQUIERDA NEGRO	4 3/8"	1 5/8"	0.209 KG



PIÑAS / CANASTAS



CODIGO	DESCRIPCION	LARGO	GROSOR
ASHT-0017X	CANASTA B-515 (1 1/2" Ø 5" ALTO) [] 1/2"	5"	1 1/2"
ASHT-0039X	CANASTA B-520 (1 3/4" Ø 5" ALTO) [] 1/2"	5"	1 3/4"
ASHT-0014	CANASTA B-521 (2 1/4" Ø 5 1/4" ALTO) (710) [] 1/2"	5 1/4"	2 1/4"
ASHT-0051	CANASTA B-522 (2 1/4" Ø 5 1/2" ALTO) (709) [] 1/2"	5 1/2"	2 1/4"

CHAPETONES CAL. 14

CODIGO	NOMBRE	ACABADO
ASHT-0148	CHICO "FLOR" L-211CRN (NEGRO) CON REMACHE	NATURAL
ASHT-0136	CHICO "FLOR" L-212CRN (NEGRO) CON REMACHE	NATURAL
ASHT-0138	CHICO "FLOR" L-212SRG (GALVANIZADO) SIN REMACHE	NATURAL
ASHT-0093	CHICO "FLOR" L-411CRT (TROPICALIZADO) CON REMACHE	NATURAL
ASHT-0151	CHICO (FLOR) L-211 S/REM. 3/8" Ø INT. 2 1/4" Ø EXT.	NATURAL
ASHT-0139	CHICO (FLOR) L-212 S/REM. 3/8" Ø INT. 2 1/4" Ø EXT.	NATURAL
ASHT-0142	CHICO (FLOR)L-210 C/REM. 3/8" Ø INT. 2 1/4" Ø EXT.	NATURAL
ASHT-0145	CHICO (FLOR)L-210 S/REM. 3/8" Ø INT. 2 1/4" Ø EXT.	NATURAL
ASHT-0189	ESTRELLA L-100REG (GALVANIZADO) CON REMACHE	NATURAL
ASHT-0190	ESTRELLA L-100REN (NEGRO) CON REMACHE	NATURAL
ASHT-0091	GRANDE "FLOR" L-411CRN (NEGRO) CON REMACHE NEGRO	NATURAL
ASHT-0119	GRANDE (FLOR) L-410 C/REM. 3/8" Ø INT. 3 1/2" Ø EXT	NATURAL
ASHT-0120	GRANDE (FLOR) L-410 S/REM. 3/8" Ø INT. 3 1/2" Ø EXT	NATURAL
ASHT-0122	GRANDE (FLOR) L-410 S/REM. 3/8" Ø INT. 3 1/2" Ø EXT	NATURAL
ASHT-0121	GRANDE (FLOR) L-410 S/REM.3/8" Ø INT. 3 1/2" Ø EXT.	NATURAL
ASHT-0090	(FLOR) L-411 C/REM.3/8" Ø INT. 3 3/4" Ø EXT.	NATURAL
ASHT-0089	GRANDE (FLOR) L-411 S/REM. 3/8" Ø INT. 3 3/4" Ø EXT	NATURAL
ASHT-0022	GRANDE (FLOR) L-411SRN S/REM.3/8" Ø INT. 3 3/4" Ø E	NATURAL
ASHT-0133	GRANDE (FLOR) L-412 S/REM. 3/8" Ø INT. 3 1/2" Ø EXT	NATURAL
ASHT-0130	GRANDE (FLOR)L-412CRN C/REM. 3/8" Ø INT. 3 1/2" Ø E	NATURAL
ASHT-0157	"FLORES" L-610CRN (NEGRO) CON REMACHE	NATURAL
ASHT-0160	"FLORES" L-611CRN (NEGRO) CON REMACHE	NATURAL
ASHT-0154	"FLORES" L-612CRN (NEGRO) CON REMACHE	NATURAL



ASHT-0148



ASHT-0145



ASHT-0136



ASHT-0151



ASHT-0157



ASHT-0154



ASHT-0160

ASHT-0190



ASHT-0090



ASHT-0089



ABASTECEDORA DE SOLDADURA Y HERRAJES S.A. DE C.V.

MIER Y NORIEGA No. 304 NTE. C.P. 67100 CD. GUADALUPE, N.L. MEXICO

Conmutador: (81) 83-54-83-45 Fax: (81) 83-54-83-45

admonventas@ashmex.com www.ashmex.com

ASH IMPORT & EXPORT LLC

601-E CEDAR AVE, SUITE E MC ALLEN, TX 78501 USA

PHONE/FAX : (956) 8004448 CELL PHONE: (956) 3880948

ashiellc@hotmail.com ashimportexport@gmail.com www.ashmex.com

BISAGRAS TUBULARES & ESPECIALES

BISAGRA RECTANGULAR NEGRA MAQUINADA C/ GRASERA

CODIGO	DESCRIPCION
ASH-0888	BISAGRA RECTANGULAR 4" X 1" X 1/2"
ASH-0889	BISAGRA RECTANGULAR 5" X 1 1/2" X 3/4"
ASH-0890	BISAGRA RECTANGULAR 6" X 2" X 1"



BISAGRA TUBULAR DOBLE C/GRASERA

CODIGO	DESCRIPCION	DIAMETRO
ASH-0574	3/4" CON 2 GRAS 2 HEM	3/4"
ASH-0573	1" CON 2 GRAS 2 HEM.	1"
ASH-0575	1 1/4" CON 2 GRAS 2 HEM.	1 1/4"
ASH-0576	1 1/2" CON 2 GRAS 2 HEM.	1 1/2"



BISAGRA TUBULAR CON PLACA Y GRASERA

CODIGO	DESCRIPCION	DIAMETRO	LARGO	ANCHO	PESO
ASH-0546	BISAGRA PLACA (25.4MM.) 1"	1"	5"	1"	0.572 KG
ASH-0671	BISAGRA PLACA (32.0 MM) 1 1/4"	1 1/4"	6"	3/8"	1.091 KG
ASH-0547	BISAGRA PLACA (38.1MM.) 1 1/2"	1 1/2"	7"	3/8"	1.396 KG
ASH-0672	BISAGRA PLACA (50.8 MM) 2"	2"	8"	3/8"	3.000 KG



BISAGRA TUBULAR NEGRA MAQUINADA

CODIGO	DESCRIPCION	DIAMETRO	LARGO
ASH-0146	BISAGRA (12.7MM.) 1/2"	1/2"	2 1/4"
ASH-0147	BISAGRA (15.9MM.) 5/8"	5/8"	2 3/8"
ASH-0058	BISAGRA (19.0MM.) 3/4"	3/4"	2 3/4"
ASH-0059	BISAGRA (25.4MM.) 1"	1"	3 1/2"



BISAGRA TUBULAR FORJADA

CODIGO	DESCRIPCION	DIAMETRO	LARGO
ASH-0067	BIS. TUBULAR 3/8"	3/8"	2 3/8"
ASH-0068	BIS. TUBULAR 1/2"	1/2"	2 3/8"
ASH-0069	BIS. TUBULAR 5/8"	5/8"	2 3/8"



BISAGRA TUBULAR MAQUINADA C/GRASERA

CODIGO	DESCRIPCION	DIAMETRO	LARGO
ASH-0426	BISAGRA 5/8"	5/8"	3 3/8"
ASH-0427	BISAGRA 3/4"	3/4"	3 3/4"
ASH-0060	BISAGRA 1"	1"	4"
ASH-0061	BISAGRA 1 1/4"	1 1/4"	4 1/2"
ASH-0062	BISAGRA 1 1/2"	1 1/2"	4 3/4"
ASH-0063	BISAGRA 2"	2"	6"



BISAGRA TEJUELO

CODIGO	DESCRIPCION	DIAMETRO	LARGO
ASH-0174	TEJUELO 1"	1"	1 1/4"
ASH-0175	TEJUELO 1 1/4"	1 1/4"	1 1/2"
ASH-0176	TEJUELO 1 1/2"	1 1/2"	1 1/2"
ASH-0177	TEJUELO 2"	2"	1 1/2"
ASH-0432	TEJUELO 2 1/2"	2 1/2"	1 3/4"
ASH-0433	TEJUELO 3"	3"	2 1/2"



BISAGRA ANCLA

CODIGO	DESCRIPCION	LARGO	ANCHO
ASH-0035	ANCLA 3/4"	4"	4"
ASH-0036	ANCLA 1"	4"	4"
ASH-0038	ANCLA 1 1/4"	4"	4"
ASH-0037	ANCLA 1 1/2"	5 1/4"	4 1/2"
ASH-0039	ANCLA 2"	6"	5 1/4"

ABASTECEDORA DE SOLDADURA Y HERRAJES S.A. DE C.V.

MIER Y NORIEGA No. 304 NTE. C.P. 67100 CD. GUADALUPE, N.L. MEXICO

Conmutador: (81) 83-54-83-45 Fax: (81) 83-54-83-45

admonventas@ashmex.com www.ashmex.com

ASH IMPORT & EXPORT LLC

601-E CEDAR AVE, SUITE E MC ALLEN, TX 78501 USA

PHONE/FAX : (956) 8004448 CELL PHONE: (956) 3880948

ashiellc@hotmail.com ashimportexport@gmail.com www.ashmex.com

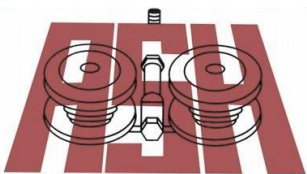

BISAGRA DE ANCLA



Medidas

3/4", 1", 1 1/4", 1 1/2", 2"

***Solera 3/16"**

***Fabricada en acero al carbón**

***Con Ancla para obtener mejor fijación en el cemento**

Usos: Ideal para puertas y portones.

www.ashmex.com

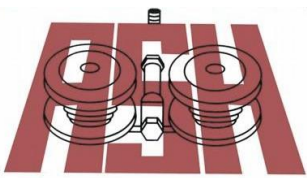

TEJUELOS



Medidas

1", 1 1/4", 1 1/2", 2", 2 1/2", 3"
****Usos: Ideal para puertas y portones.***

www.ashmex.com

ABASTECEDORA DE SOLDADURA Y HERRAJES S.A. DE C.V.
MIER Y NORIEGA No. 304 NTE. C.P. 67100 CD. GUADALUPE, N.L. MEXICO
Conmutador: (81) 83-54-83-45 Fax: (81) 83-54-83-45
admonventas@ashmex.com www.ashmex.com

ASH IMPORT & EXPORT LLC
601-E CEDAR AVE, SUITE E MC ALLEN, TX 78501 USA
PHONE/FAX : (956) 8004448 CELL PHONE: (956) 3880948
ashiellc@hotmail.com ashimportexport@gmail.com www.ashmex.com

BISAGRA TIPO BANDERA

CODIGO	DESCRIPCION
ASH-1000	BISAGRA TIPO BANDERA CAL 11 PERNO SUELTO DE 1/2
ASH-1006	BISAGRA TIPO BANDERA CAL 11 PERNO SUELTO DE 3/8

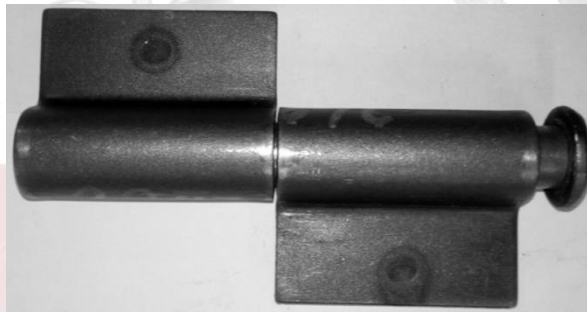

BISAGRA DOBLE TUBO CED. 40 CON PERNO SUELTO 3/4"



TAPAS DECORATIVAS

TAPA PARA PTR



CODIGO	DESCRIPCION
ASH-0652	TAPA PARA PTR 1/2" DECORATIVA CAL 18
ASH-0655	TAPA PARA PTR 3/4" DECORATIVA CAL 18
ASH-0657	TAPA PARA PTR 1/2" DECORATIVA CAL 18
ASH-0653	TAPA PARA PTR 1" DECORATIVA CAL. 18
ASH-0656	TAPA PARA PTR 1-1/4" DECORATIVA CAL 16
ASH-0654	TAPA PARA PTR 1-1/2" DECORATIVA CAL 16
ASH-0646	TAPA PARA PTR 2" DECORATIVA CAL 14
ASH-0647	TAPA PARA PTR 2-1/2" DECORATIVA CAL 14
ASH-0648	TAPA PARA PTR 3" DECORATIVA CAL.14
ASH-0649	TAPA PARA PTR 3-1/2" DECORATIVA CAL.12
ASH-0650	TAPA PARA PTR 4" DECORATIVA CAL.12

TAPA PARA TUBO MECANICO

CODIGO	MEDIDAS
ASH-0773	MECANICO 1" CAL 12
ASH-9999	MECANICO 3/4" CAL 12
ASH-0775	MECANICO 1 1/4" CAL 12
ASH-0774	MECANICO 1 1/2" CAL 12
ASH-0776	MECANICO 2" CAL 12
ASH-0777	MECANICO 2 1/2" CAL 12
ASH-0778	MECANICO 3" CAL 12
ASH-0780	MECANICO 3 1/2" CAL 12
ASH-0779	MECANICO 4"



TAPA PARA TUBO COMERCIAL

CODIGO	DESCRIPCION
ASH-0734	3/4 COMERCIAL(1/2 ESFERA-BOTON)CAL 14
ASH-0736	1" COMERCIAL(1/2 ESFERA-BOTON)CAL 14
ASH-0737	1 1/4" COMERCIAL(1/2 ESFERA-BOTON)CAL 14
ASH-0738	1 1/2 COMERCIAL(1/2 ESFERA-BOTON)CAL 14
ASH-0739	2" COMERCIAL(1/2 ESFERA-BOTON)CAL 13
ASH-0740	2 1/2 COMERCIAL(1/2 ESFERA-BOTON)CAL 12
ASH-0741	3" COMERCIAL(1/2 ESFERA-BOTON)CAL 12
ASH-0742	3 1/2" COMERCIAL(1/2 ESFERA-BOTON)CAL 12
ASH-0743	4" COMERCIAL(1/2 ESFERA-BOTON)CAL 12



PLATOS PORTA VELA



CODIGO	DESCRIPCION	U.V.	DIAMETRO
ASH-0130	CURVO 1 1/2" CAL 18 (aprx 100 pz/ kg)	KG	1 1/2"
ASH-0131	CURVO 2" CAL 18 (aprx 47pz/ kg)	KG	2"
ASH-0132	CURVO 2 1/2" CAL 18 (aprx 33 pz/ kg)	KG	2 1/2"
ASH-0133	CURVO 3" CAL 18 (aprx 23 pz/ kg)	KG	3"
ASH-0134	CURVO 4" CAL 18 (aprx 11 pz/ kg)	KG	4"
ASH-0135	CURVO 6" CAL 18 (aprx 5 pz/ kg)	KG	6"
ASH-0136	CURVO 8" CAL 18 (aprx 3 pz/ kg)	KG	8"
ASH-0137	CHINO 1 1/2" CAL 18 (aprx 84 pz/ kg)	KG	1 1/2"
ASH-0138	CHINO 2" CAL 18 (aprx 50 pz/ kg)	KG	2"
ASH-0139	CHINO 2 1/2" CAL 18 (aprx 33 pz/ kg)	KG	2 1/2"
ASH-0140	CHINO 3" CAL 18 (aprx 17pz/ kg)	KG	3"
ASH-0141	CHINO 4" CAL 18 (aprx 12 pz/ kg)	KG	4"
ASH-0142	CHINO 6" CAL 18 (aprx 5 pz/ kg)	KG	6"
ASH-0143	CHINO 8" CAL 18 (aprx 3 pz/ kg)	KG	8"
ASH-0361	LISO 1 1/2" CAL 18 (AP. 66 PZAS. X KG.)	KG	1 1/2"
ASH-0362	LISO 2" CAL 18	KG	2"
ASH-0363	LISO 3" CAL 18	KG	2 1/2"
ASH-0364	LISO 4" CAL 18 (13PZAS. X KG)	KG	3"
ASH-0365	LISO 6" CAL.18 (6 PZAS. X KG)	KG	4"
ASH-0366	LISO 2 1/2" CAL 18 3 PZ APROX	KG	6"

ABASTECEDORA DE SOLDADURA Y HERRAJES S.A. DE C.V.

MIER Y NORIEGA No. 304 NTE. C.P. 67100 CD. GUADALUPE, N.L. MEXICO

Conmutador: (81) 83-54-83-45 Fax: (81) 83-54-83-45

admonventas@ashmex.com www.ashmex.com

ASH IMPORT & EXPORT LLC

601-E CEDAR AVE, SUITE E MC ALLEN, TX 78501 USA

PHONE/FAX : (956) 8004448 CELL PHONE: (956) 3880948

ashiellc@hotmail.com ashimportexport@gmail.com www.ashmex.com